

Teardrop

Shown at 100%

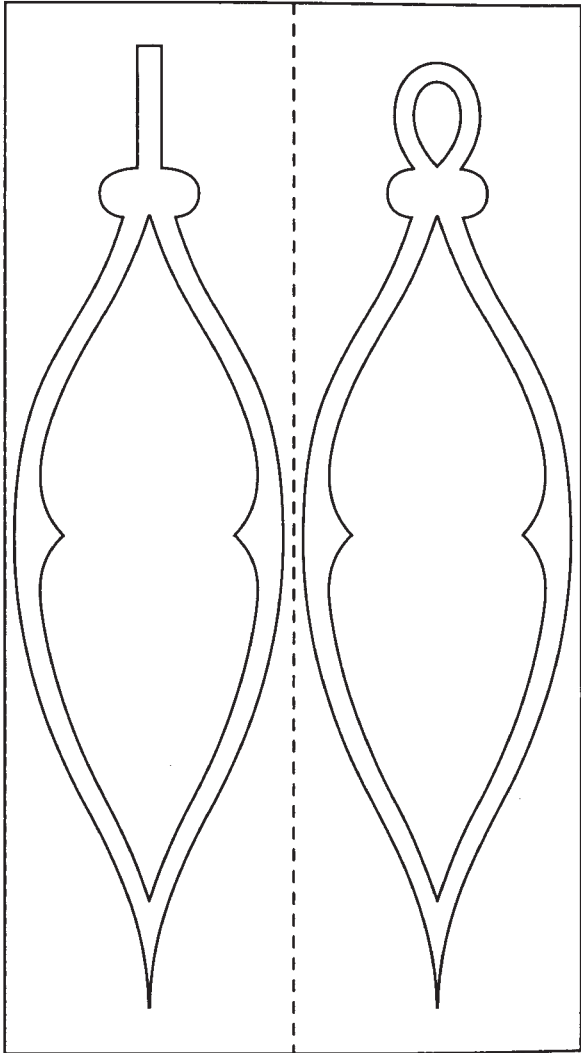

Transformation

Enlarge to 120%

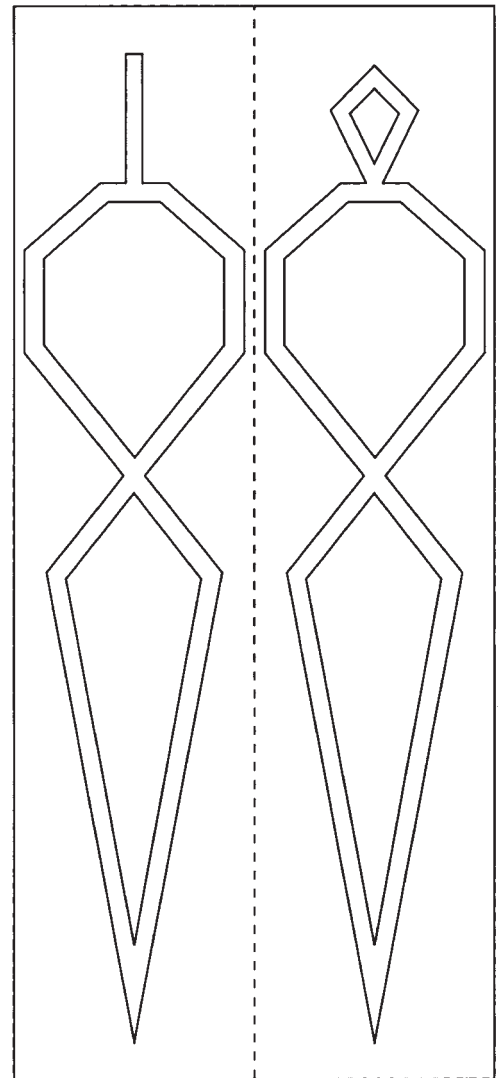

Melting Sphere

Enlarge to 120%

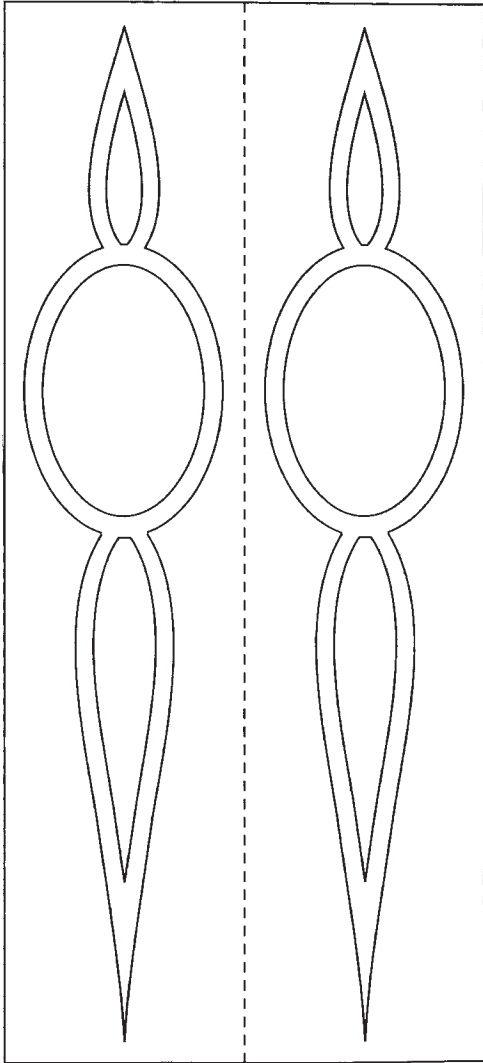

© Diana Thompson

Dangling Diamonds

Shown at 100%

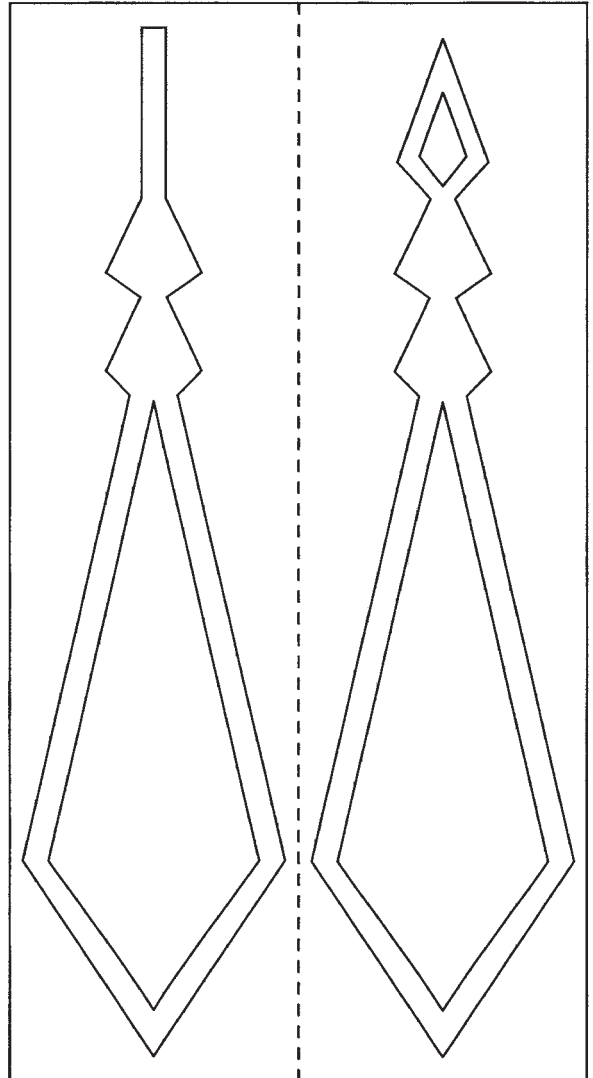

© Diana Thompson

Droplet

Shown at 100%

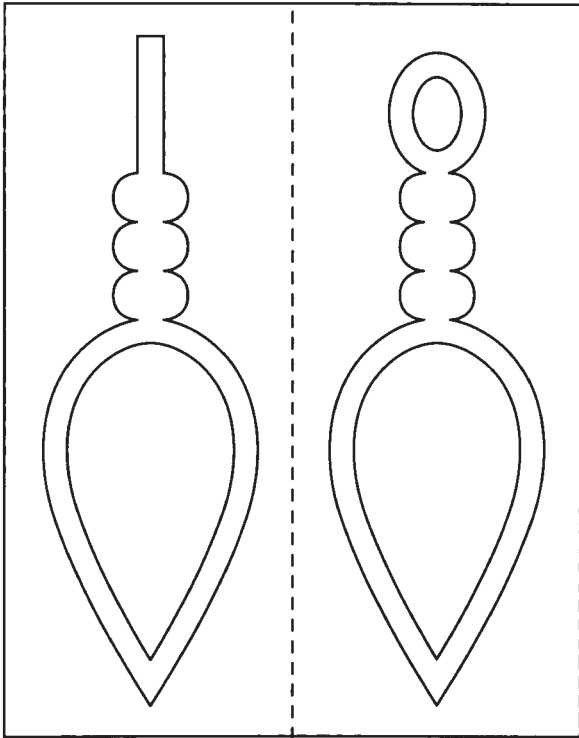

Ace

Shown at 100%

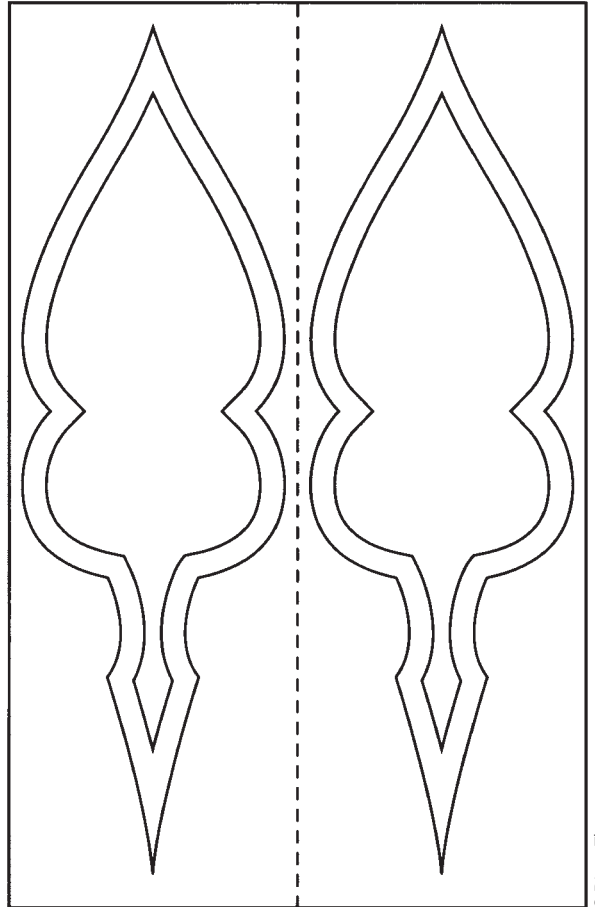

Triple Spheres

Enlarge to 105%

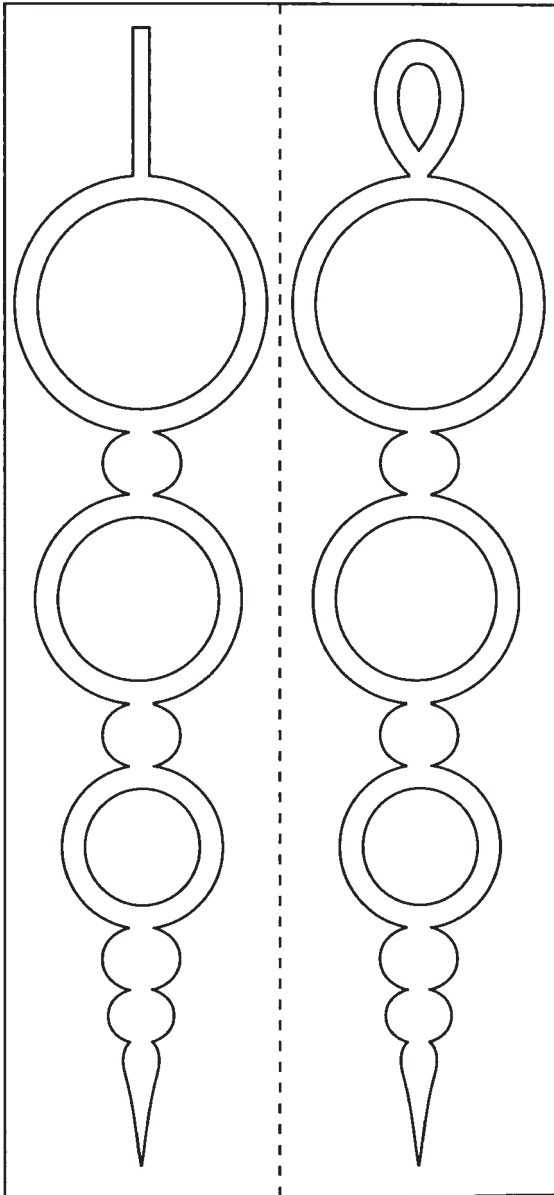

Spire

Shown at 100%

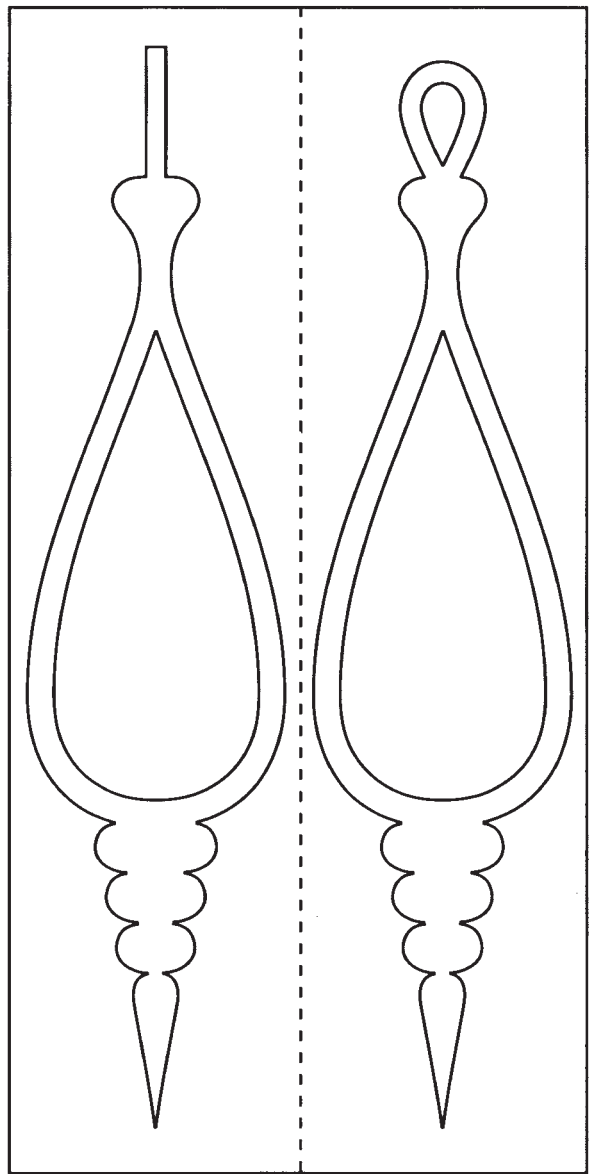

Icicle

Enlarge to 110%

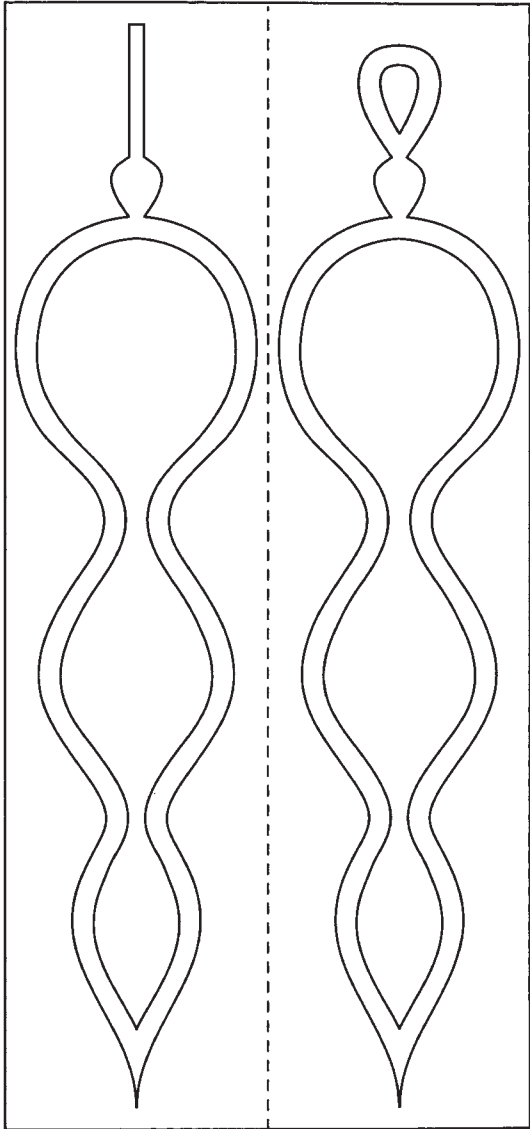

Inspiration

Enlarge to 110%

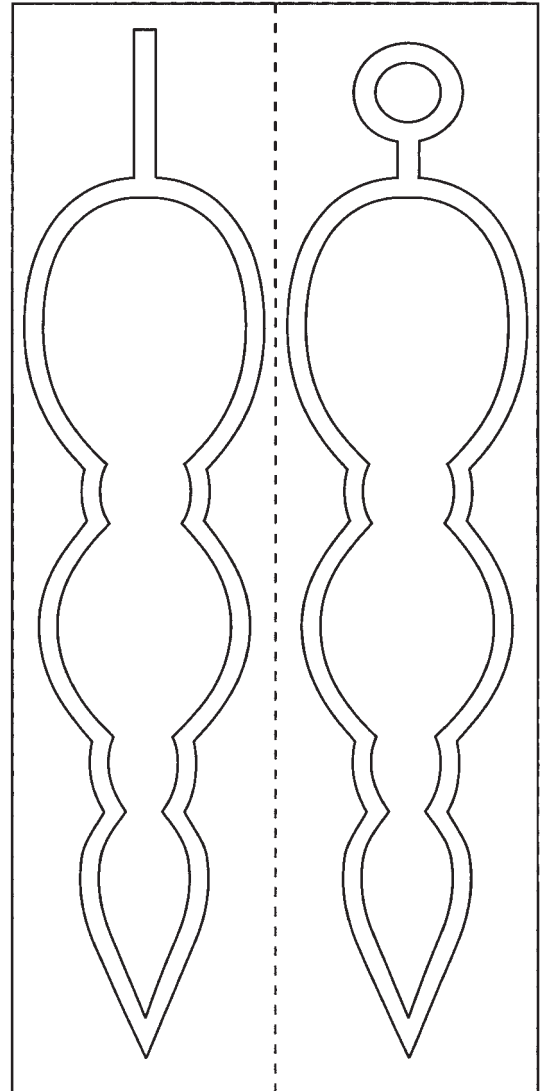

Triplet

Shown at 100%

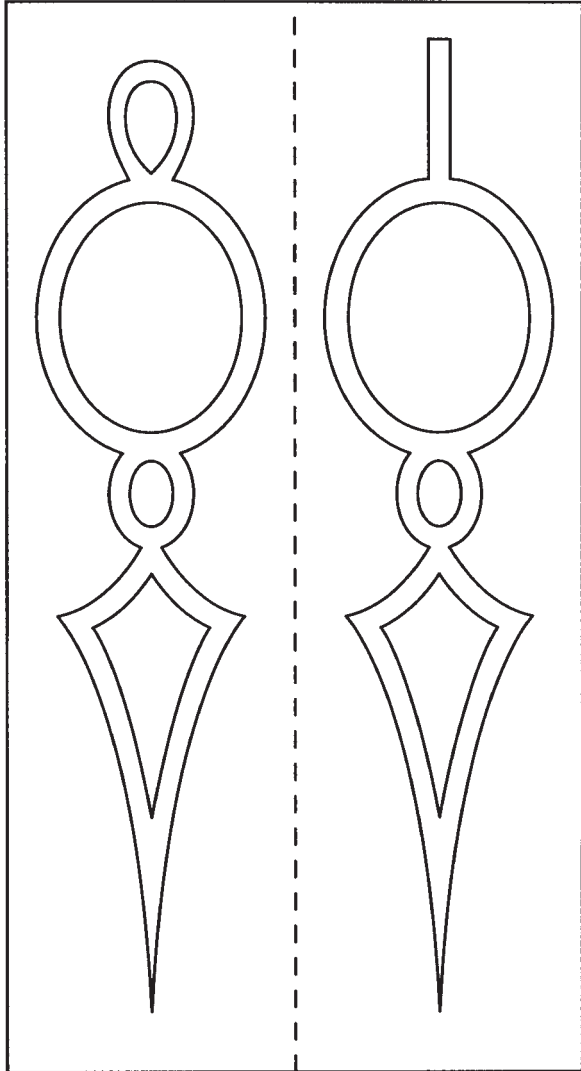

Wooden Tassel

Shown at 100%

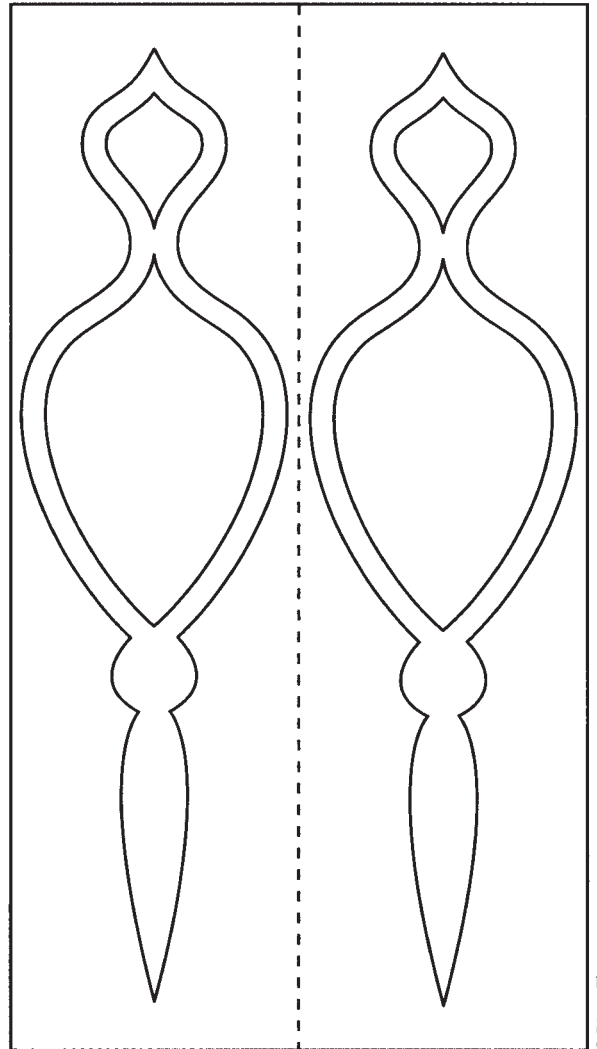

Triple Diamonds

Enlarge to 110%

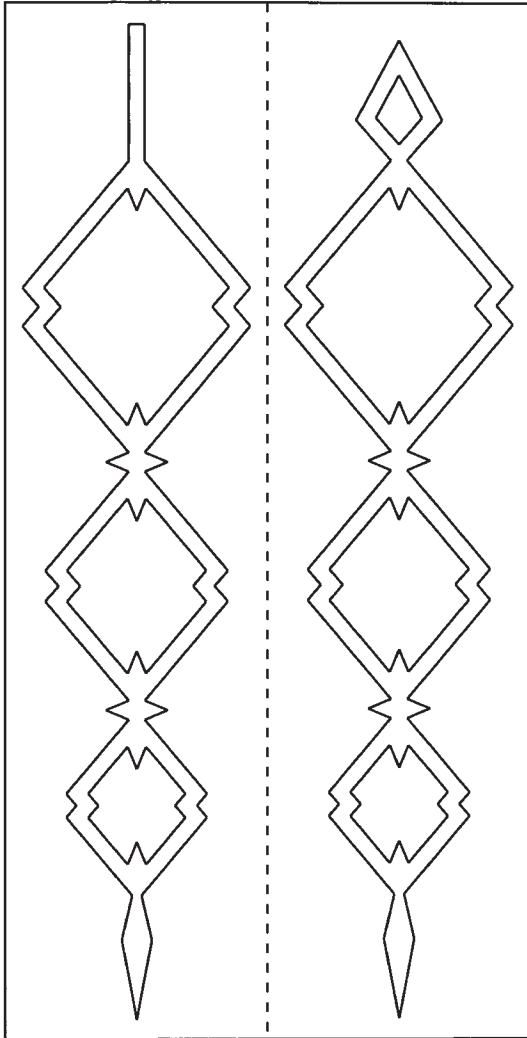

© Diana Thompson

Descent

Shown at 100%

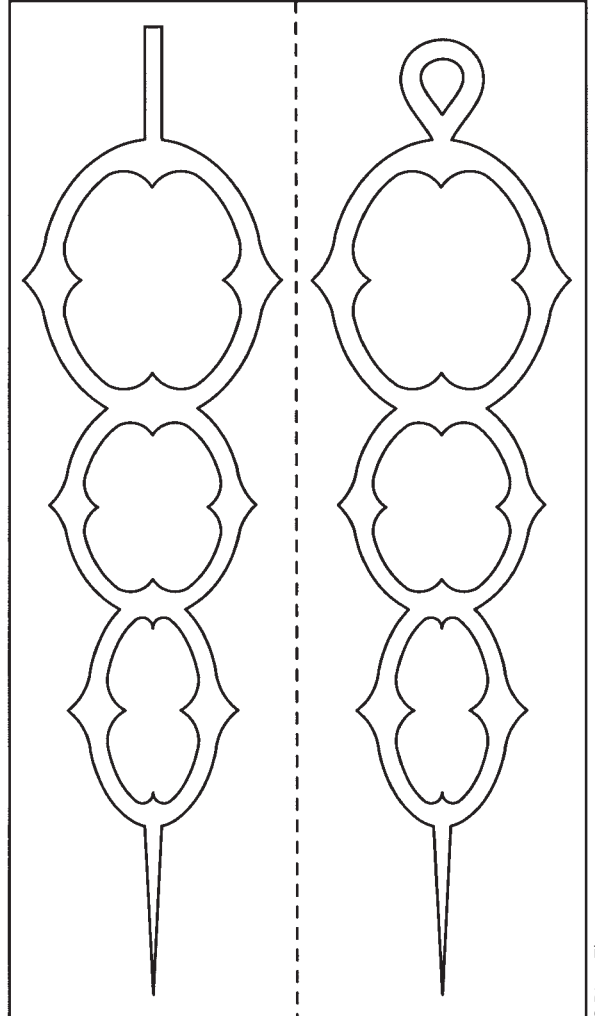

© Diana Thompson

Gravity

Shown at 100%

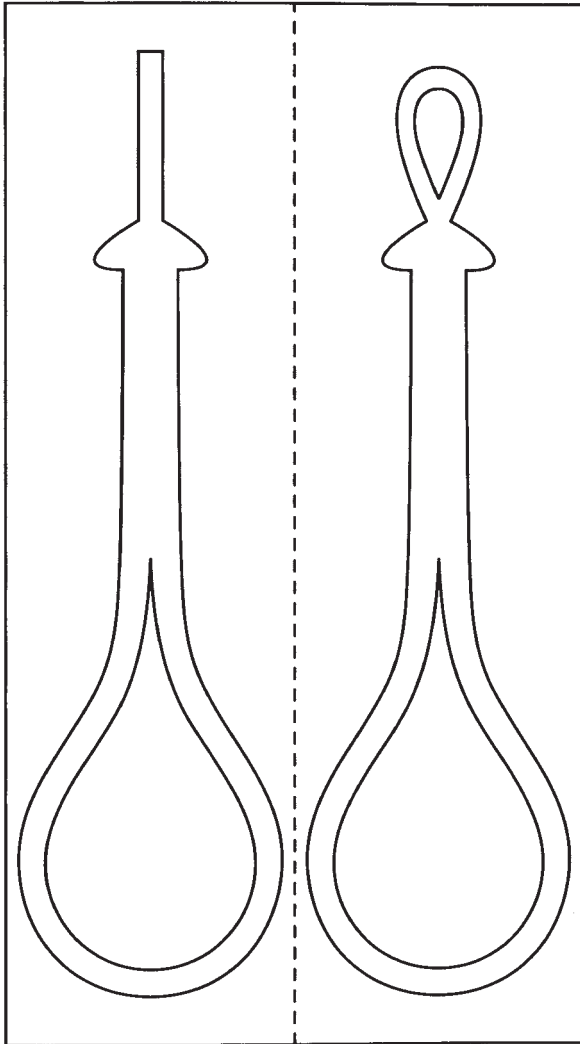

3-D Diamond

Shown at 100%

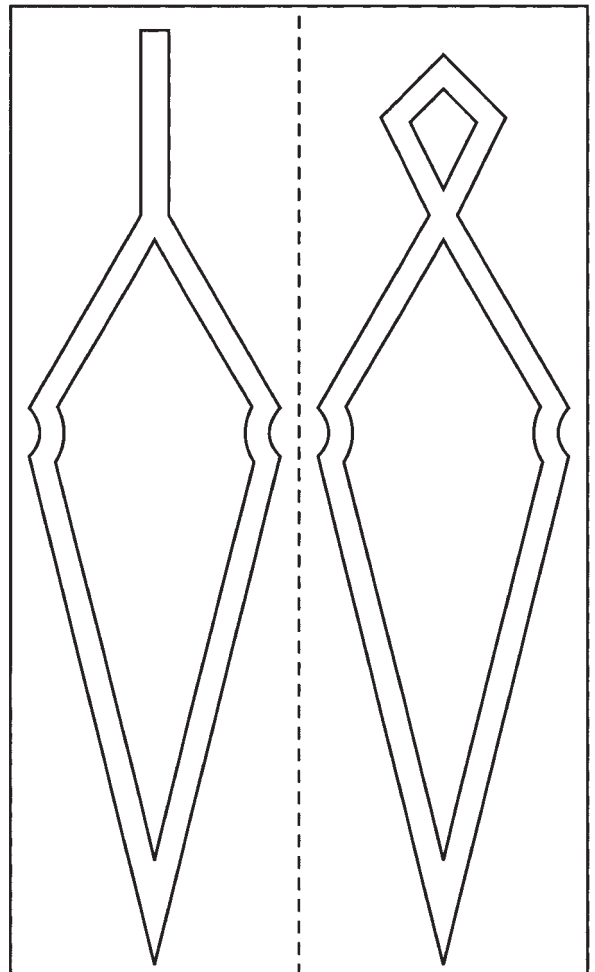

Steps

Shown at 100%

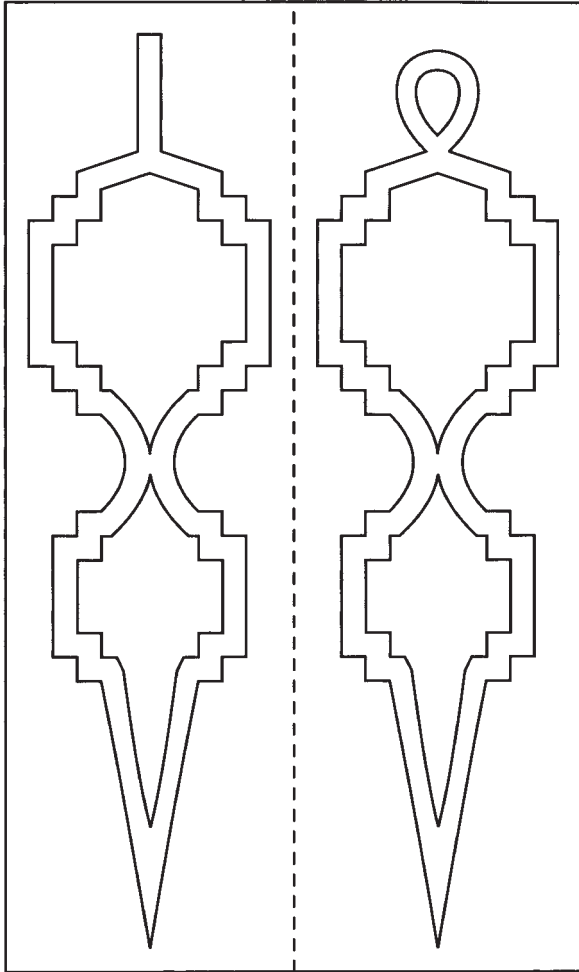

Snowman

Shown at 100%

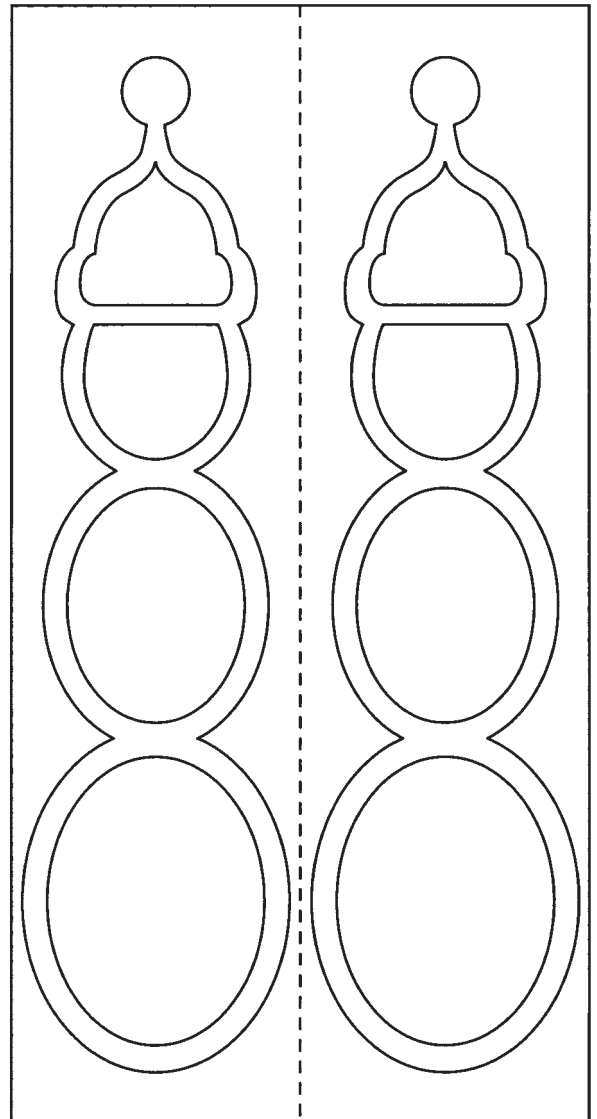

Blazing Cross

Shown at 100%

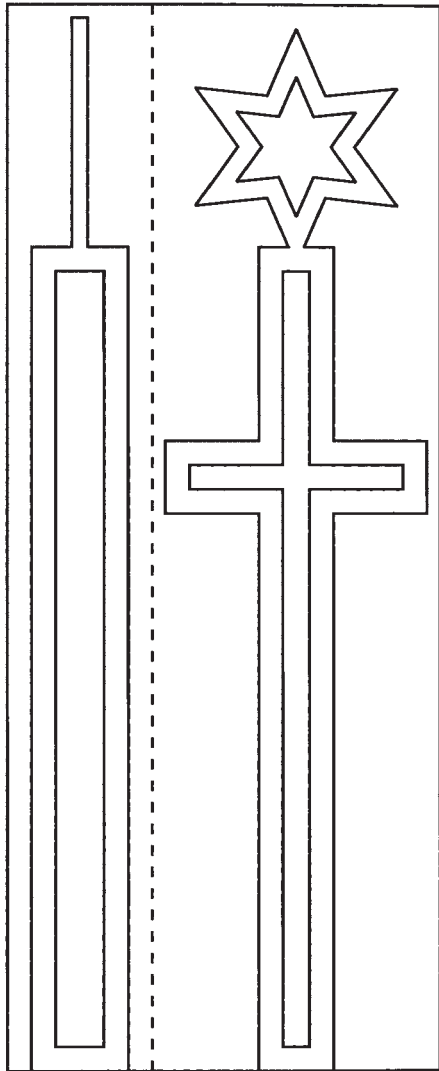

© Diana Thompson

Christmas Tree

Enlarge to 110%

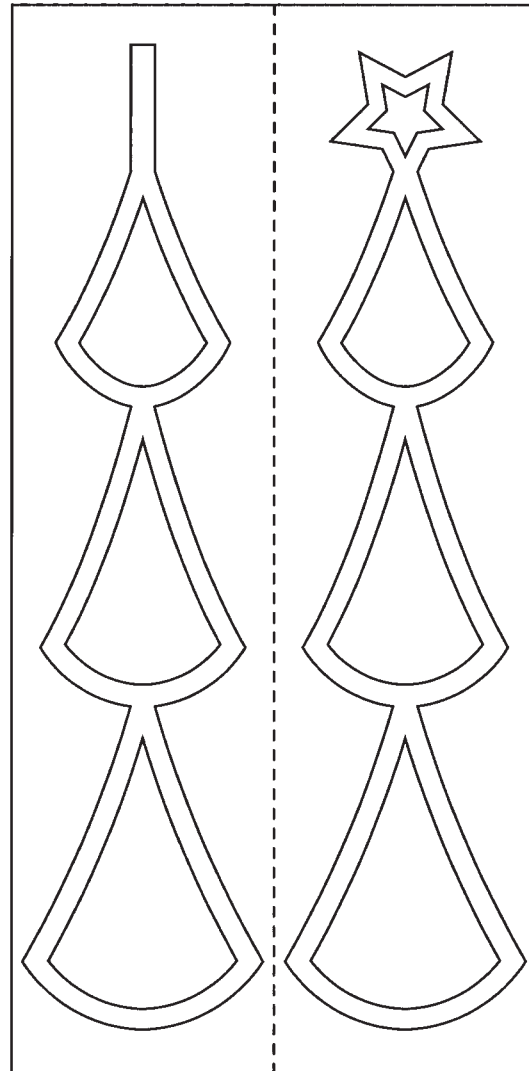

© Diana Thompson

Christmas Stocking

Shown at 100%

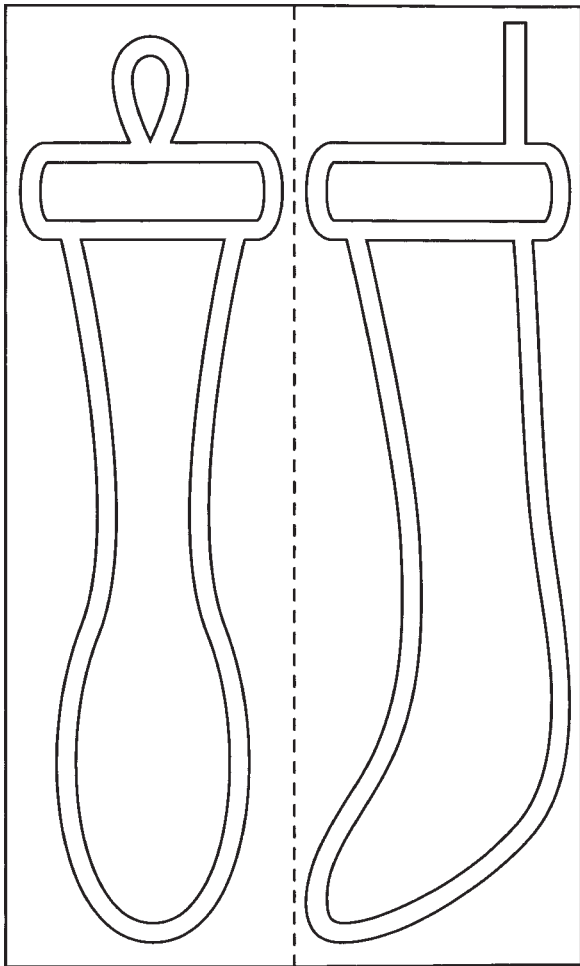

Icthyus

Shown at 100%

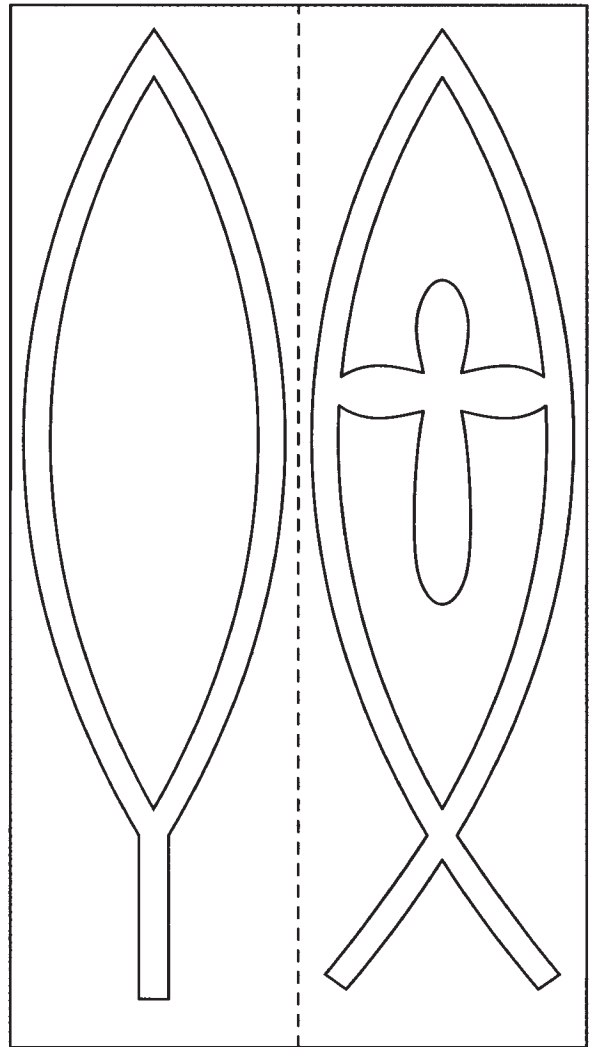

Special Treat

Shown at 100%

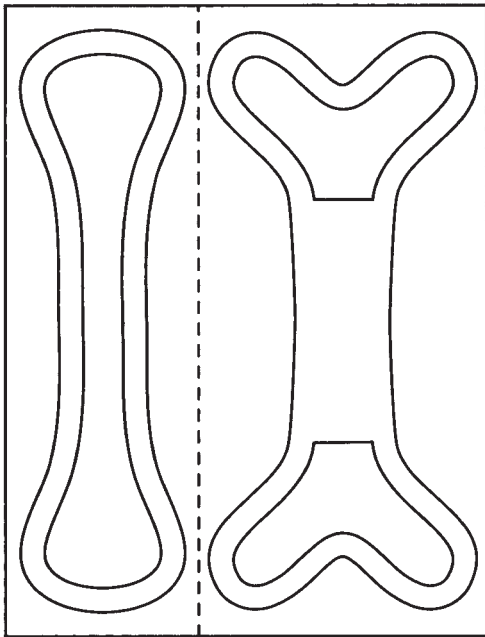

Mitten

Shown at 100%

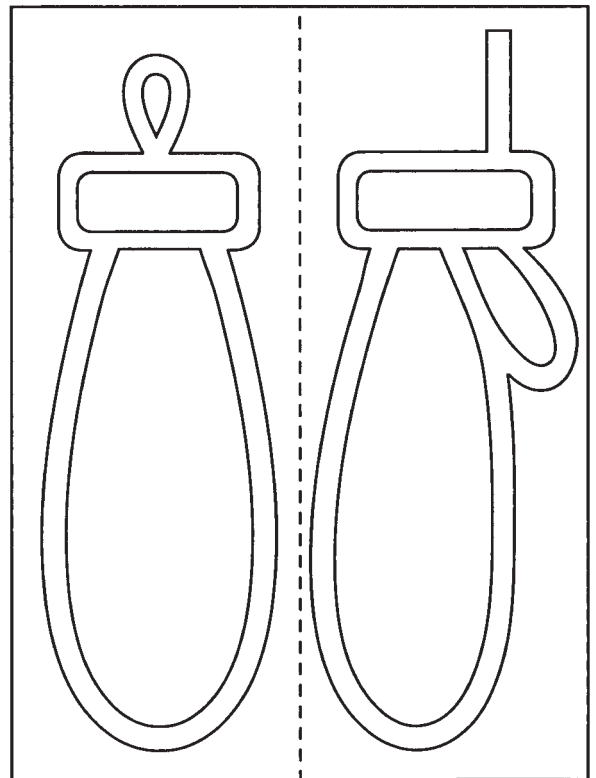

Gingerbread Man

Shown at 100%

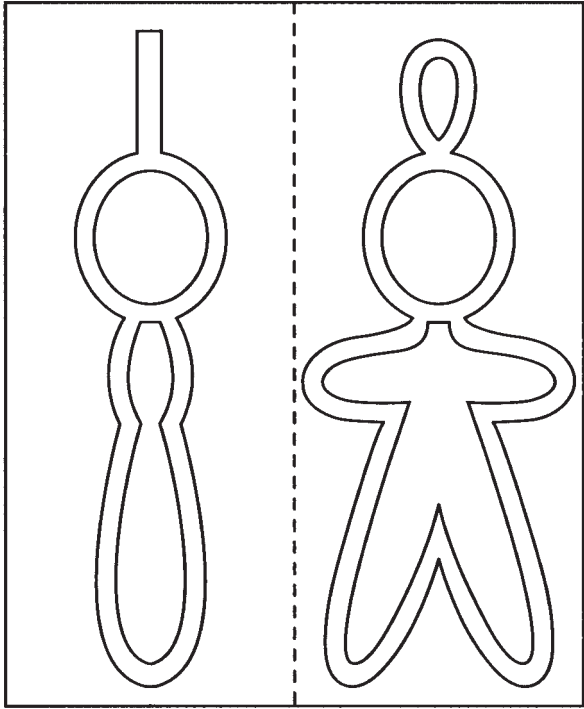

© Diana Thompson

Flaming Candle

Shown at 100%

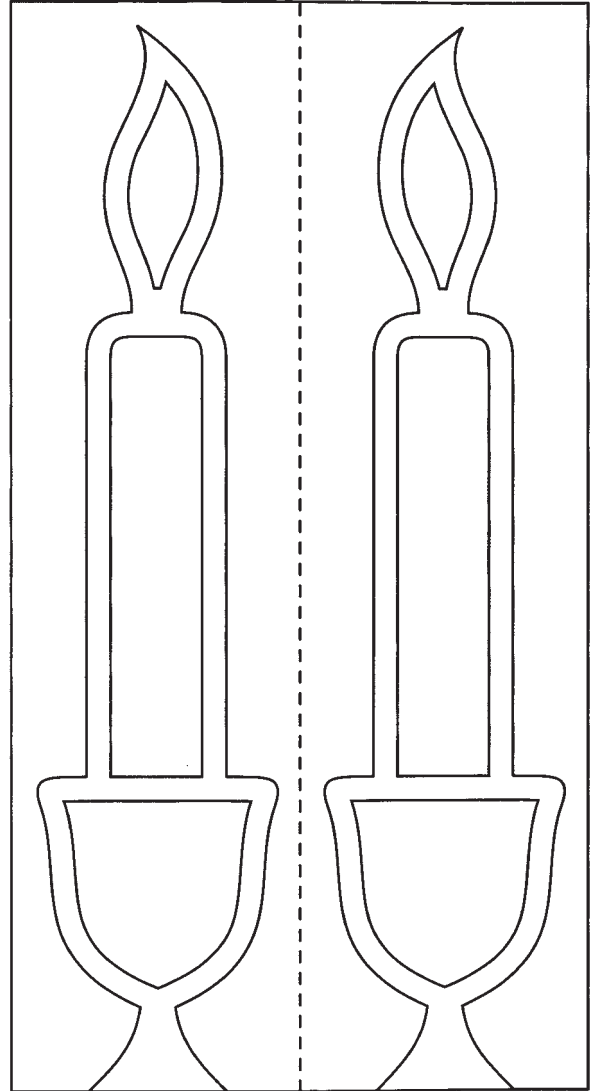

© Diana Thompson

Silver Bells

Tree Topper

Shown at 100%

Shown at 100%

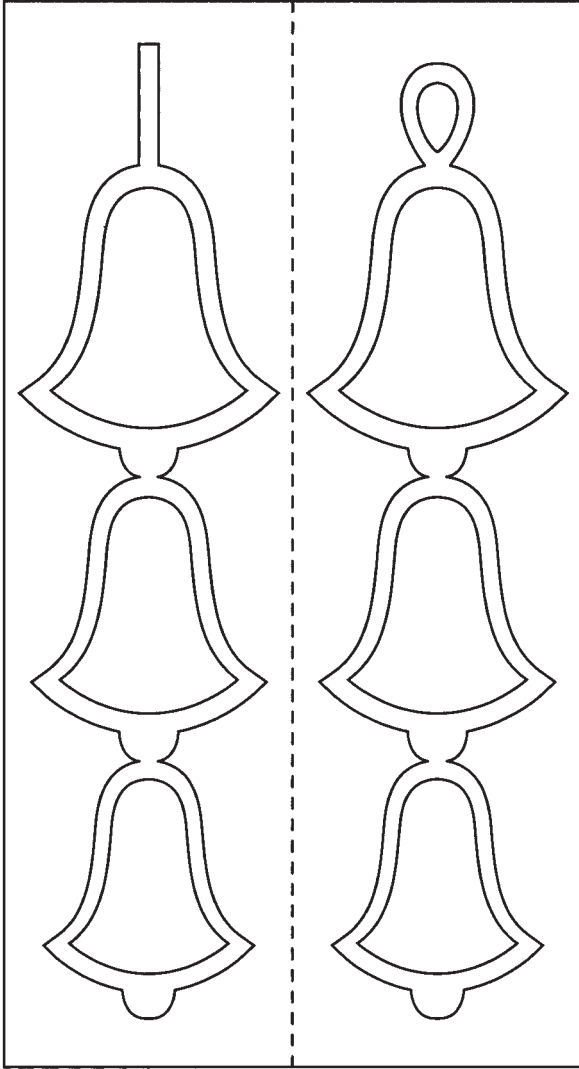

© Diana Thompson

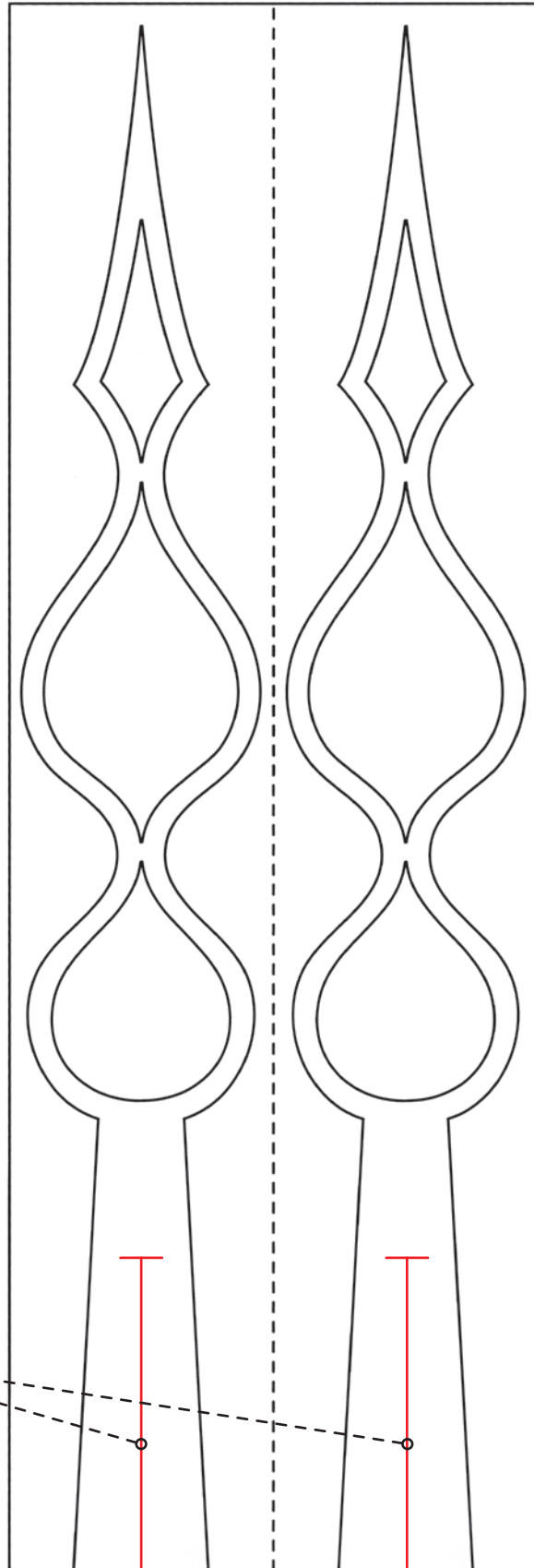

Drill a hole in the bottom to the depth line with a $\frac{3}{8}$ " Forstner bit. Cut out as usual.

© Diana Thompson

Gingerbread Boy

Shown at 100%

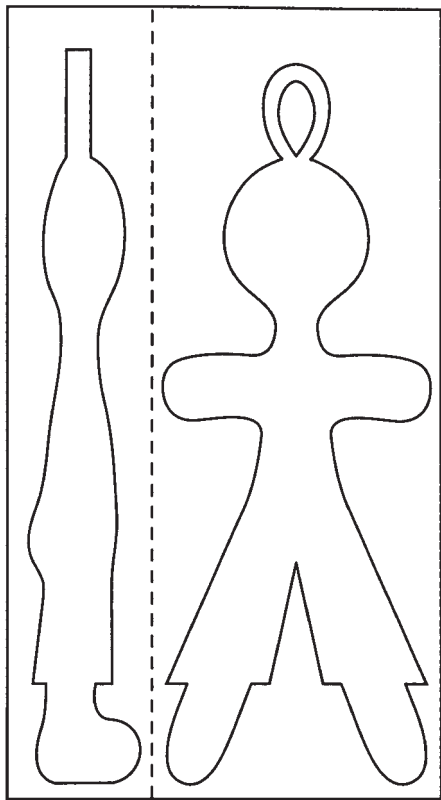

Gingerbread Girl

Shown at 100%

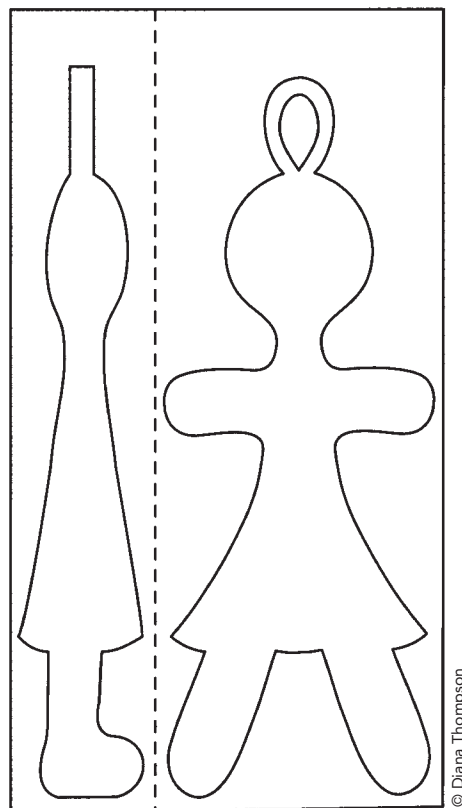

Gingerbread Man

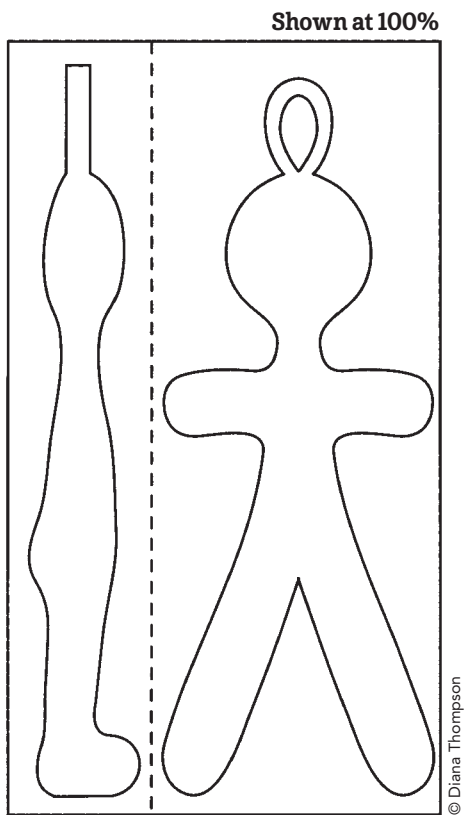

Four Candy Canes

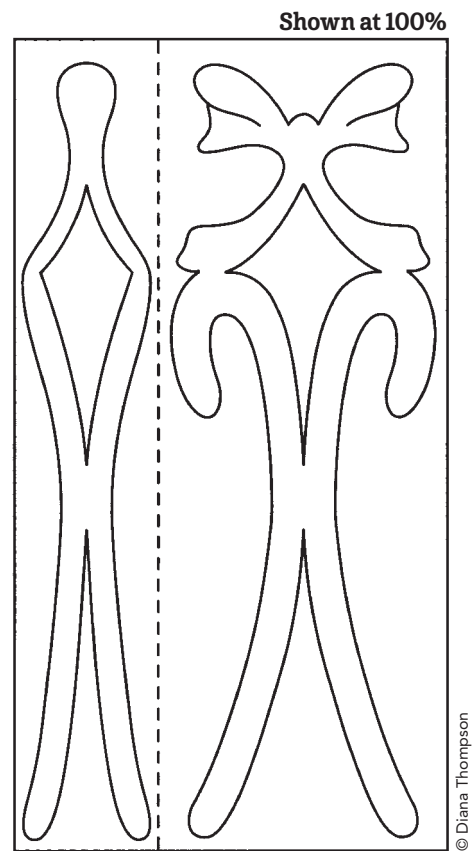

Holly Bell

Shown at 100%

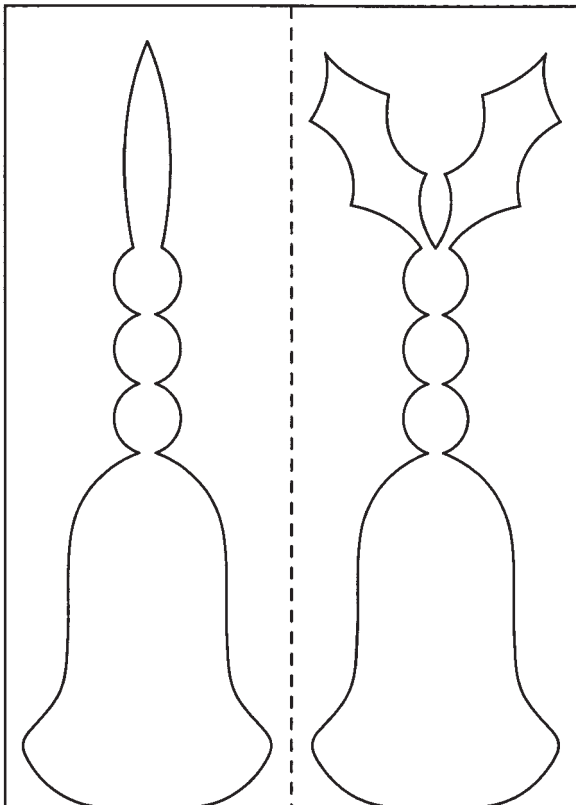

Sweet Stocking

Shown at 100%

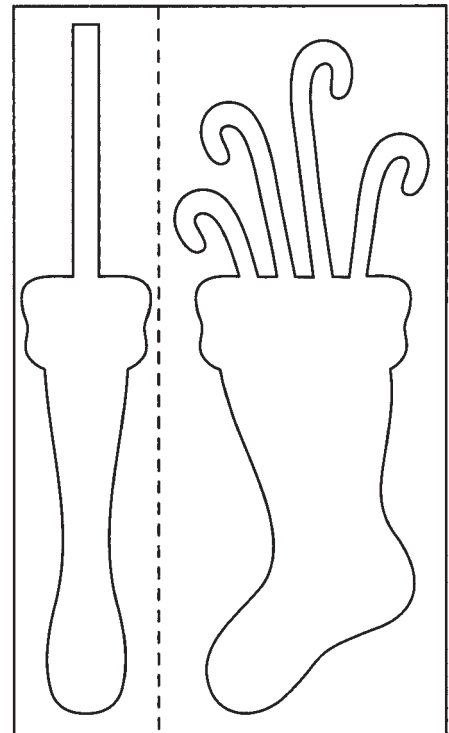

Teddy Bear Girl

Shown at 100%

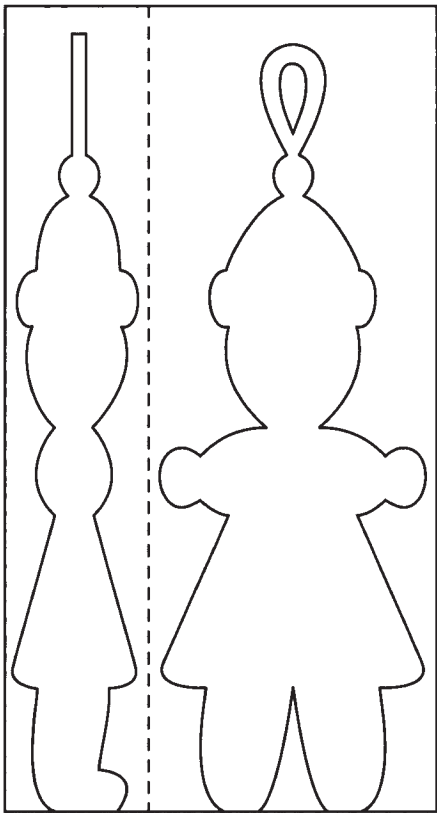

© Diana Thompson

Teddy Bear Boy

Shown at 100%

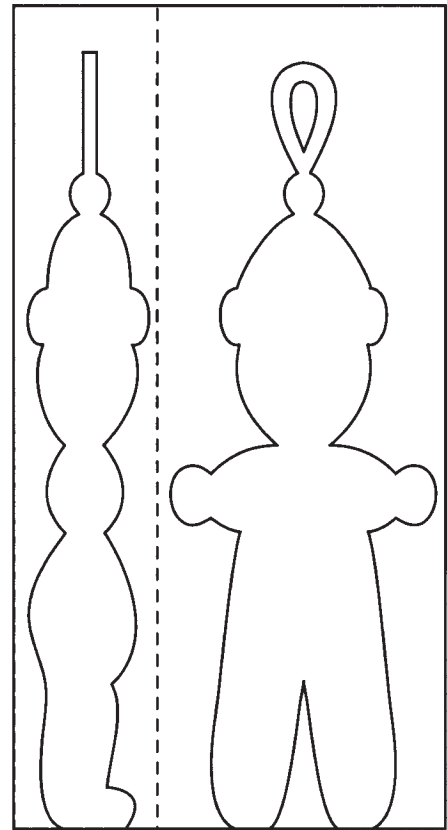

© Diana Thompson

Ice Skating Snowman

Enlarge to 110%

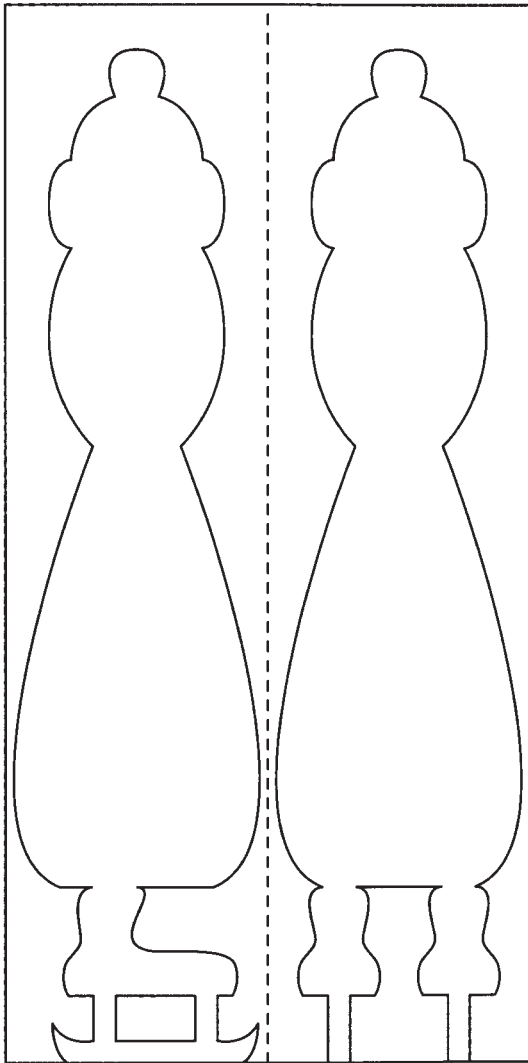

© Diana Thompson

Silly Snowman

Shown at 100%

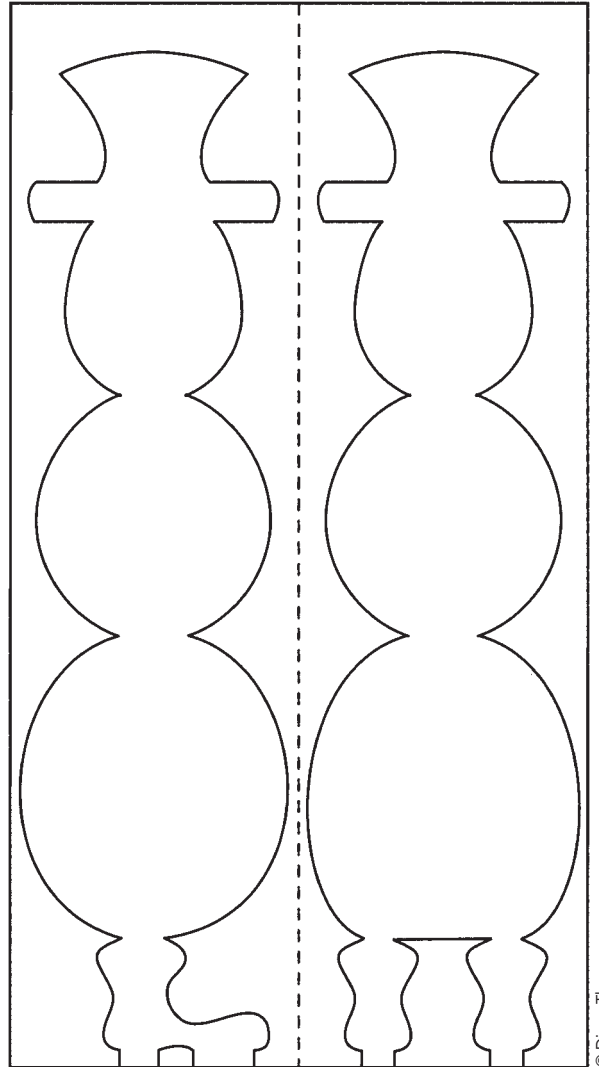

© Diana Thompson

Snowy Tree

Chubby Snowman

Shown at 100%

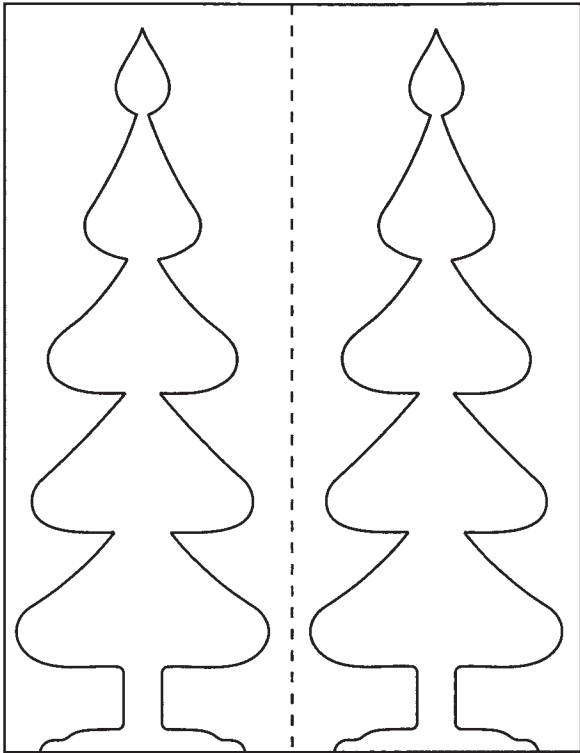

Shown at 100%

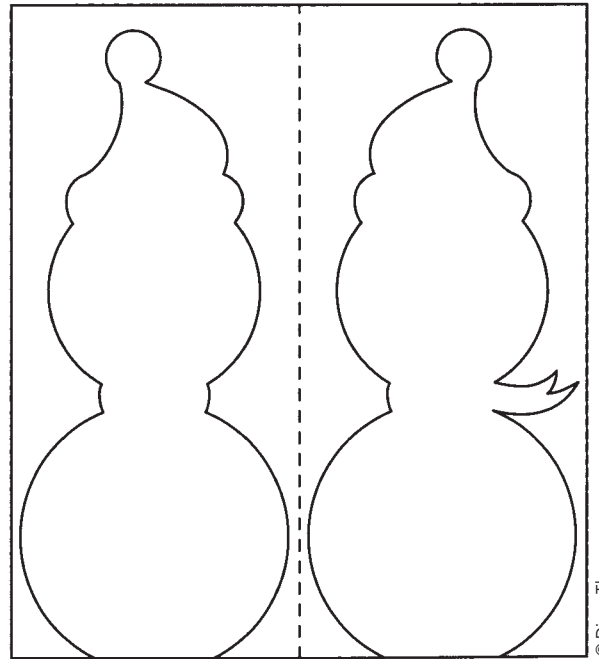

Burning Bright

Tannenbaum

Shown at 100%

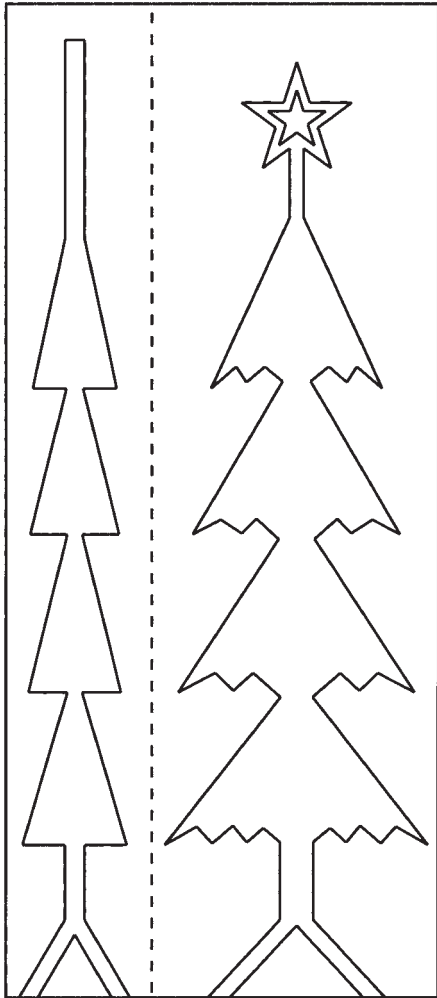

Shown at 100%

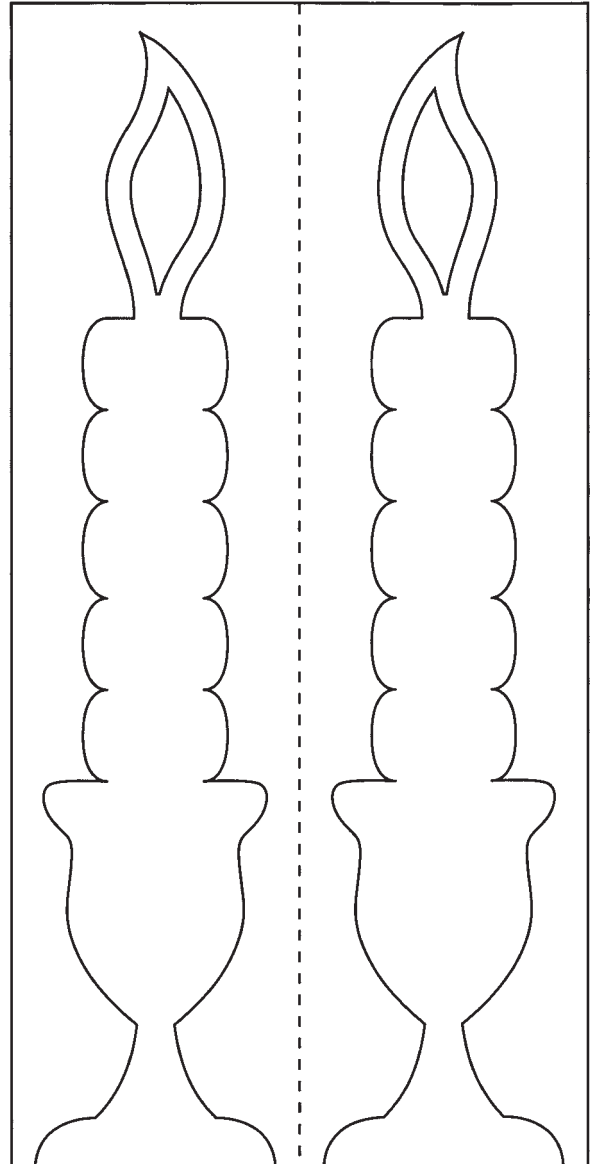

Evening Glow

Shown at 100%

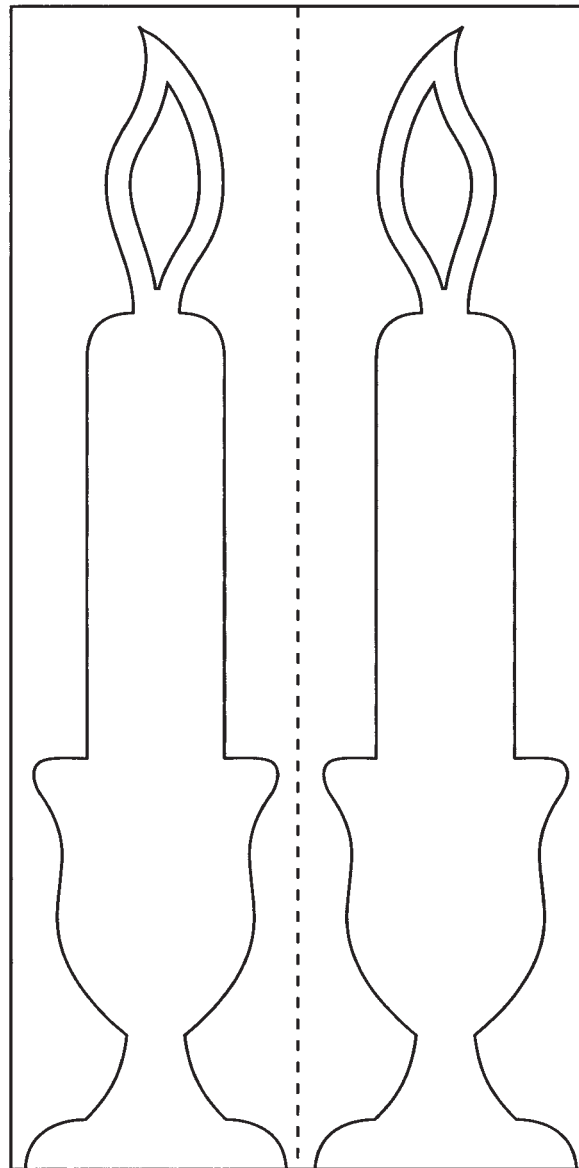

© Diana Thompson

Chilly Penguin

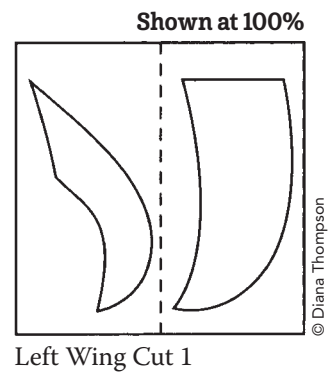
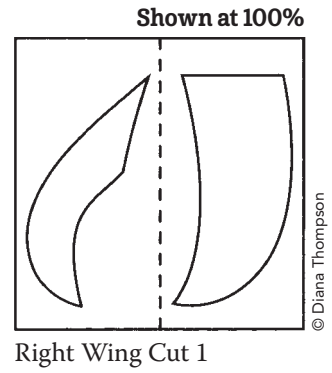
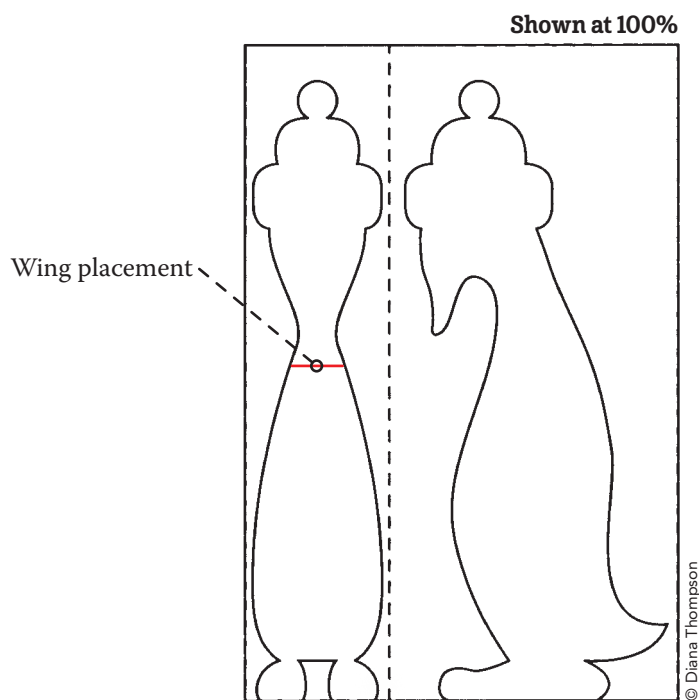

Dove of Peace

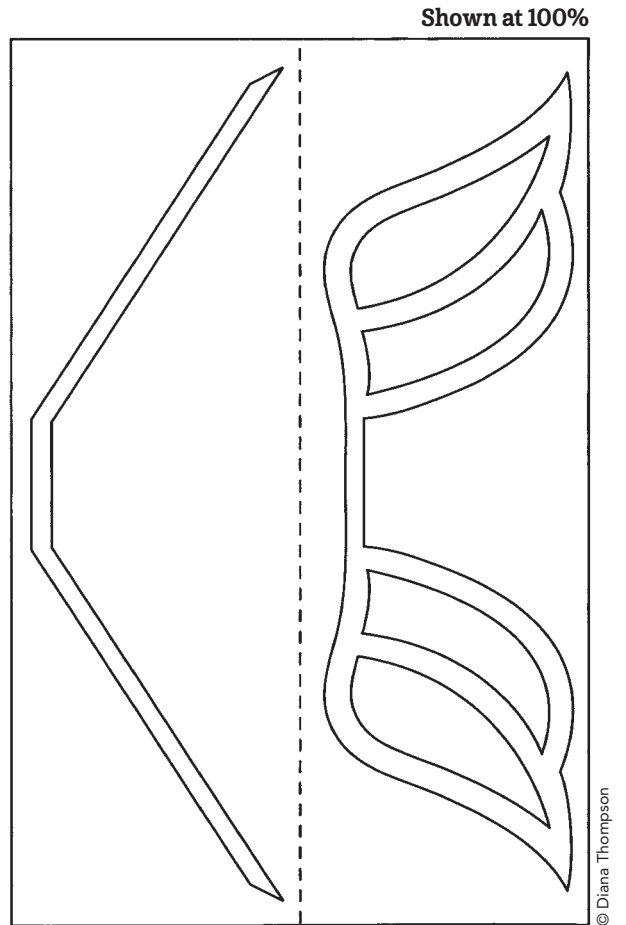
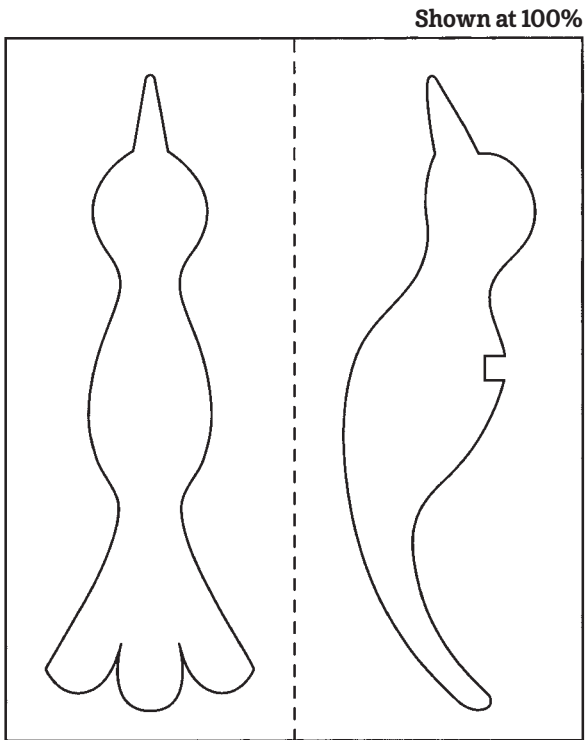

Guardian Angel

Enlarge to 110%

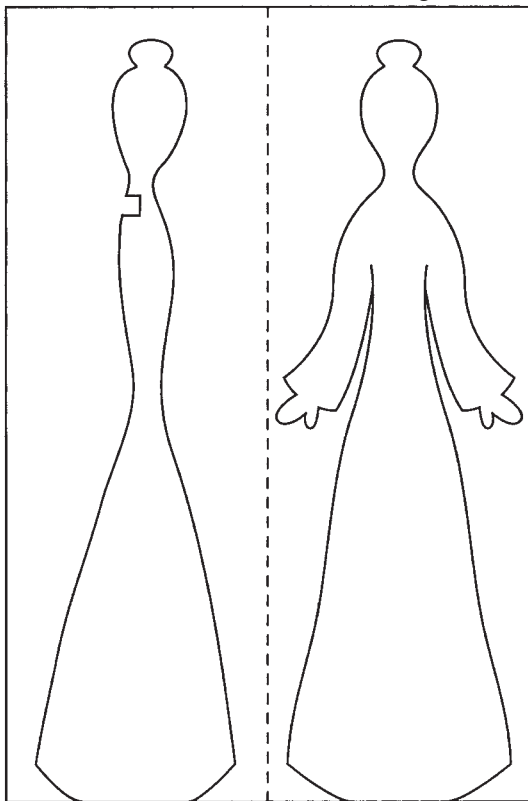

Enlarge to 110%

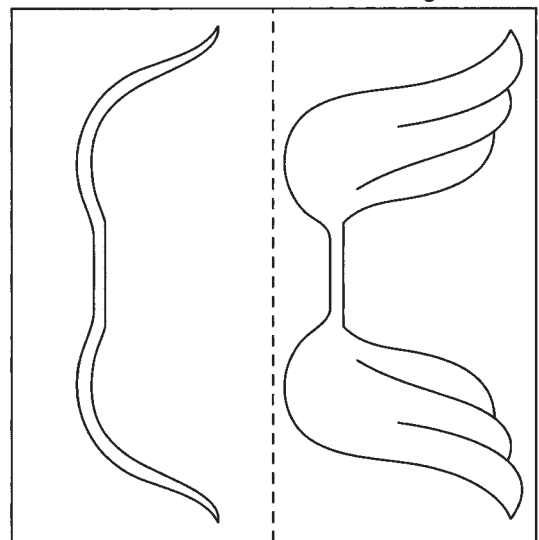

Heralding Angel

Enlarge to 110%

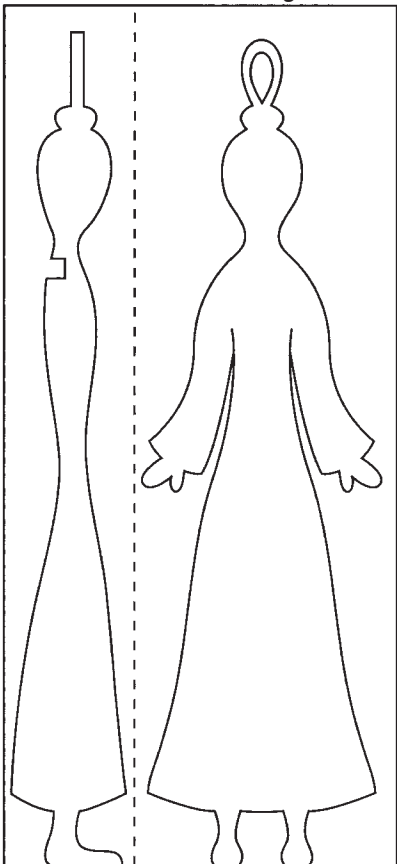

Enlarge to 110%

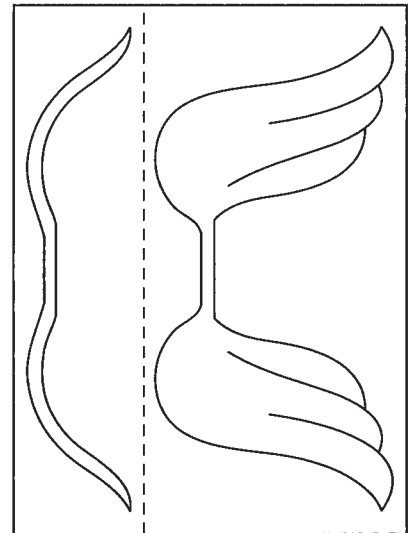

Christmas Swan

Shown at 100%

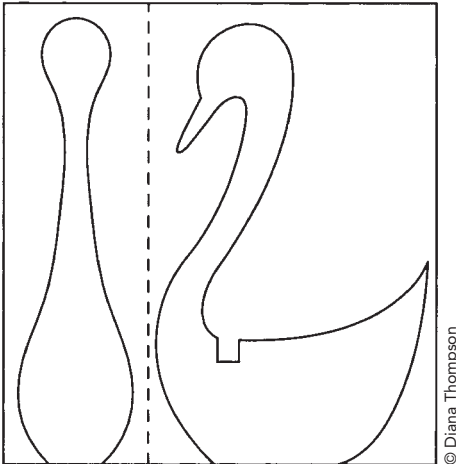

Shown at 100%

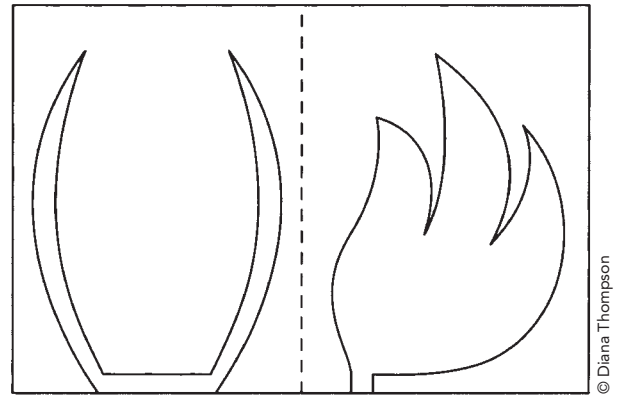

Snowmen Candlesticks

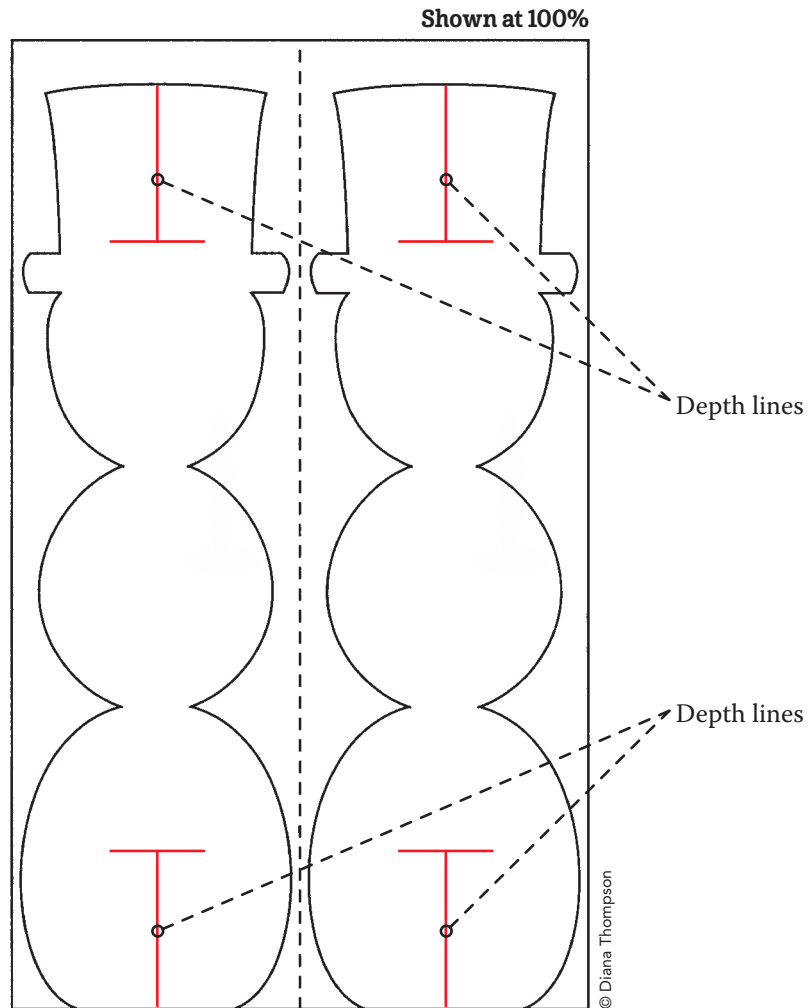

Poinsettia Centerpiece

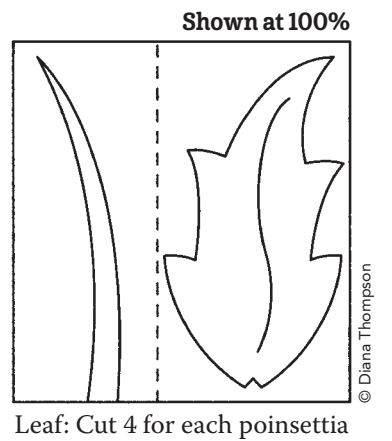
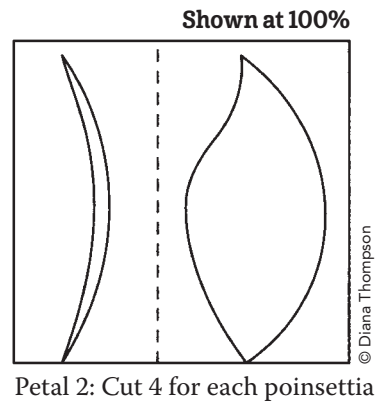
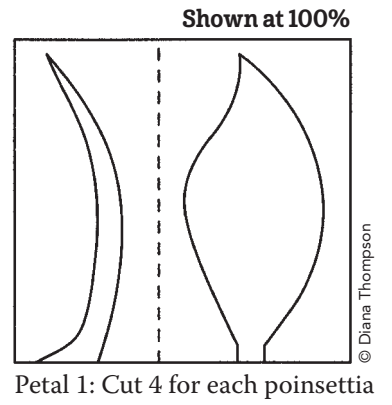
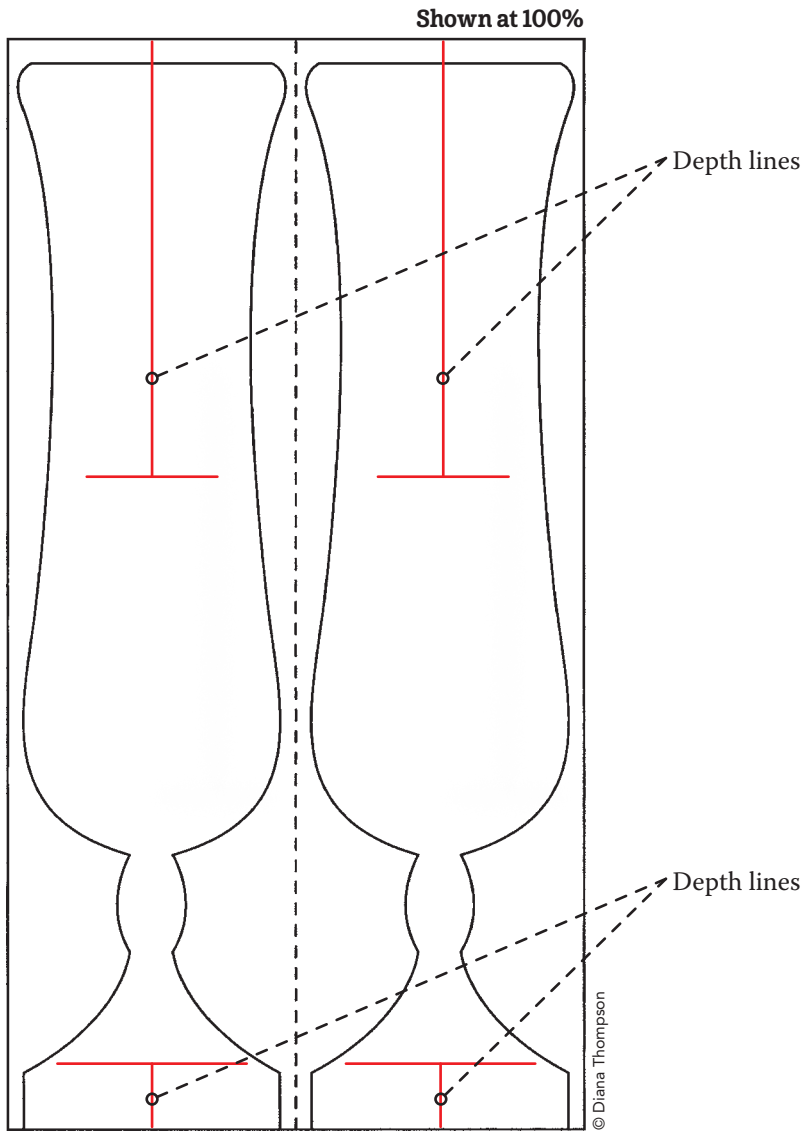

Poinsettia Centerpiece

Shown at 100%

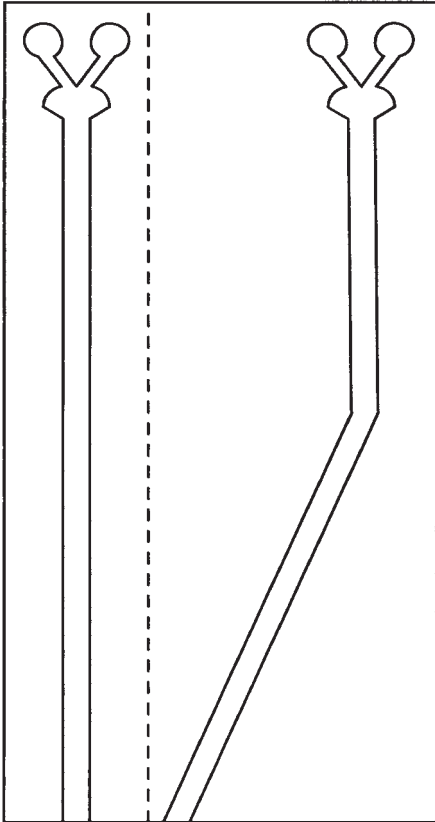

© Diana Thompson

Shown at 100%

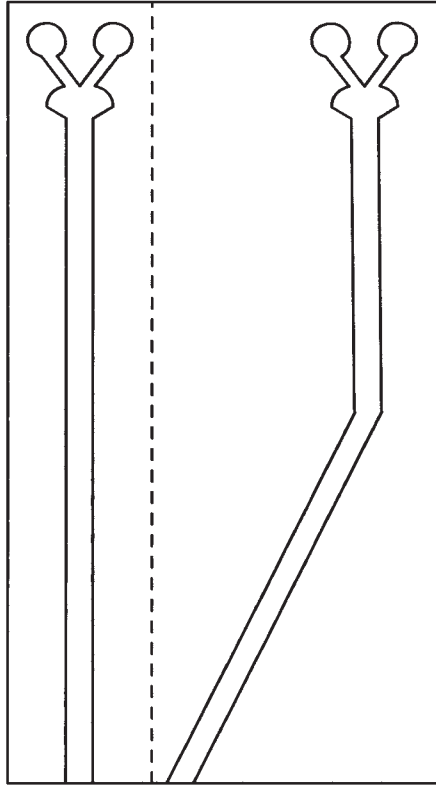

© Diana Thompson

Shown at 100%

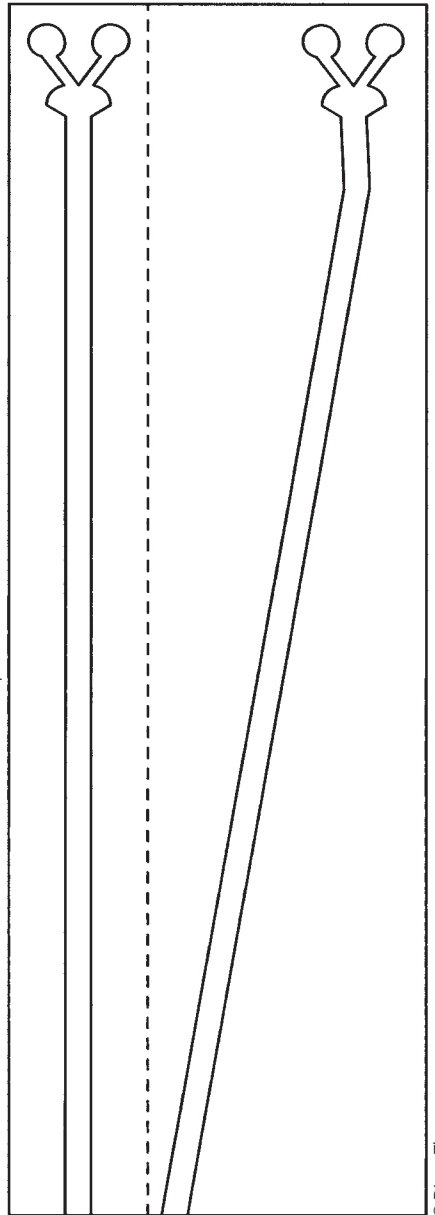

© Diana Thompson

Sleigh and Reindeer

Shown at 100%

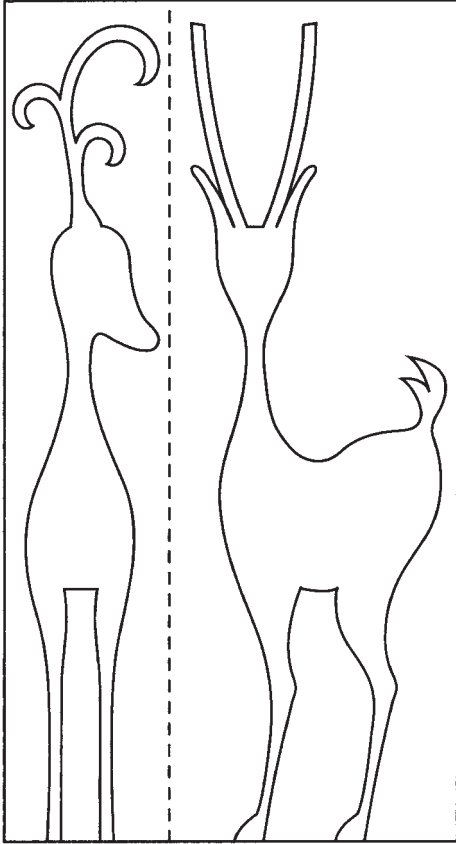

© Diana Thompson

Shown at 100%

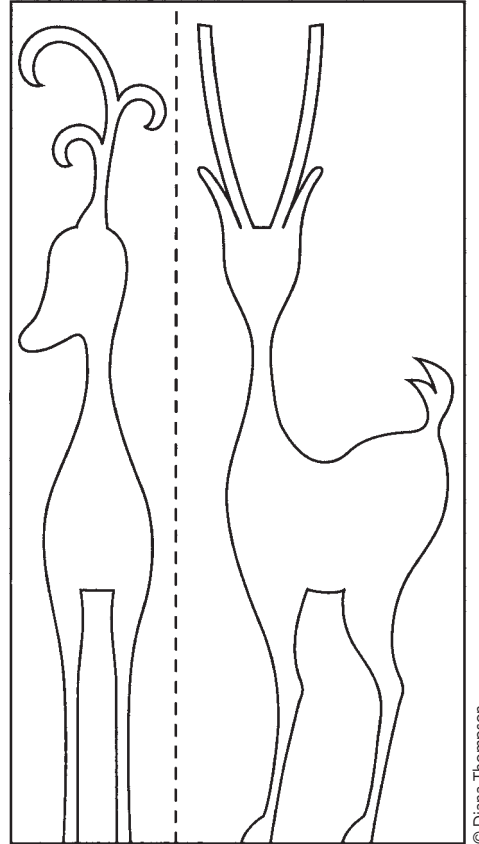

© Diana Thompson

Shown at 100%

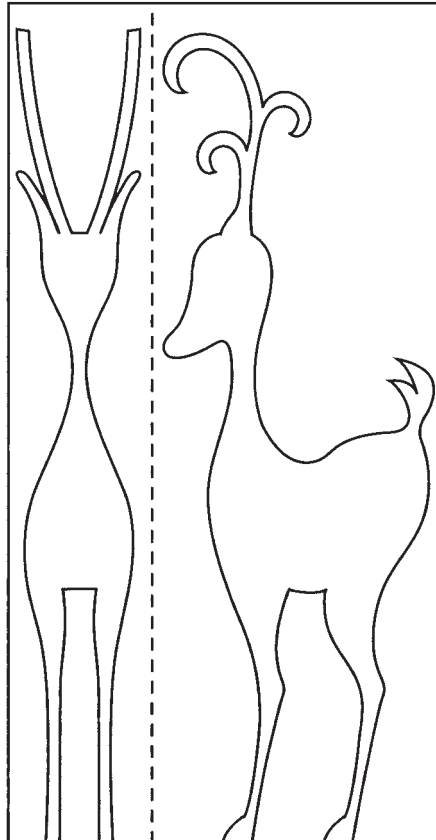

© Diana Thompson

Sleigh and Reindeer

Glue sleigh together according to dashed line diagram.

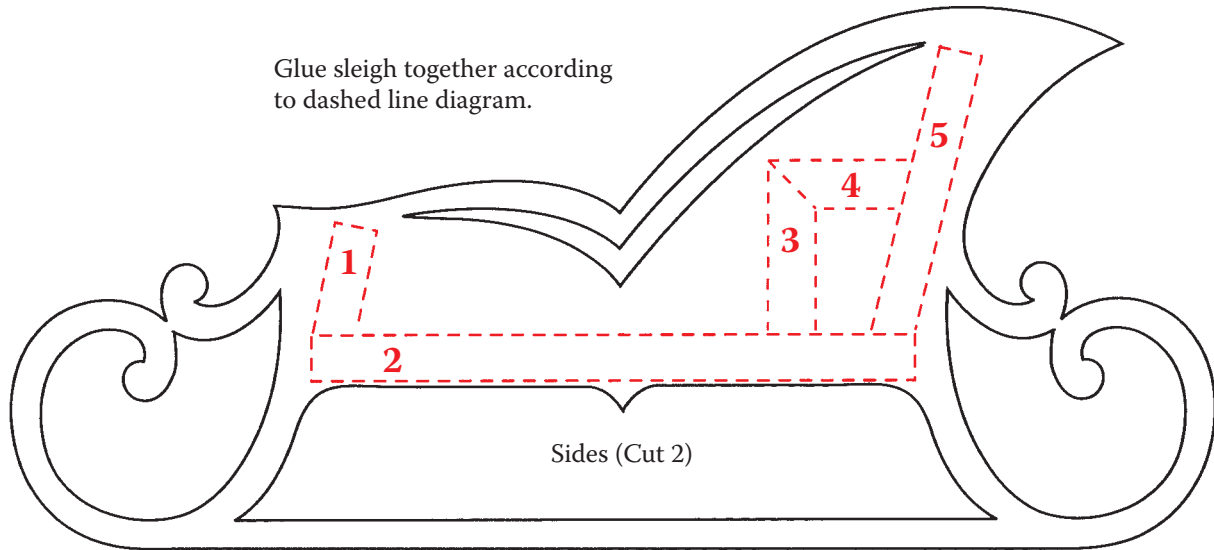

Toe (Cut 1)

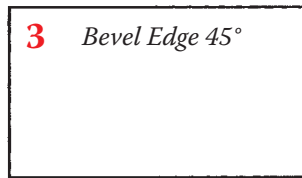

Seat Front (Cut 1)

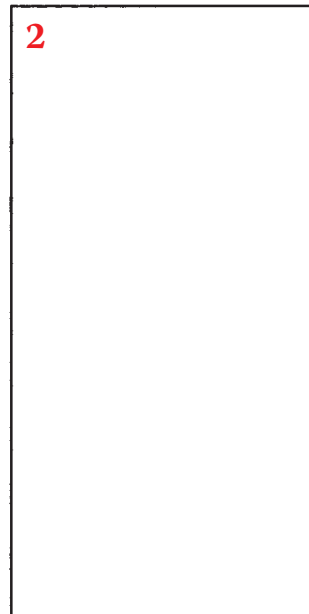

Floor (Cut 1)

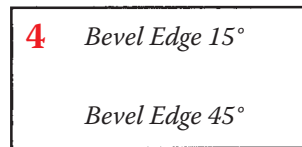

Seat (Cut 1)

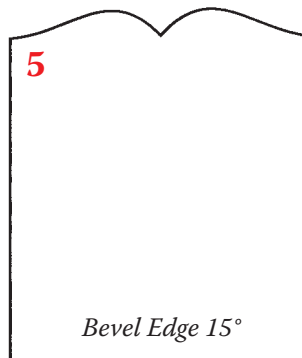

Back (Cut 1)

Use all patterns at 100%

© Diana Thompson

Nativity Scene

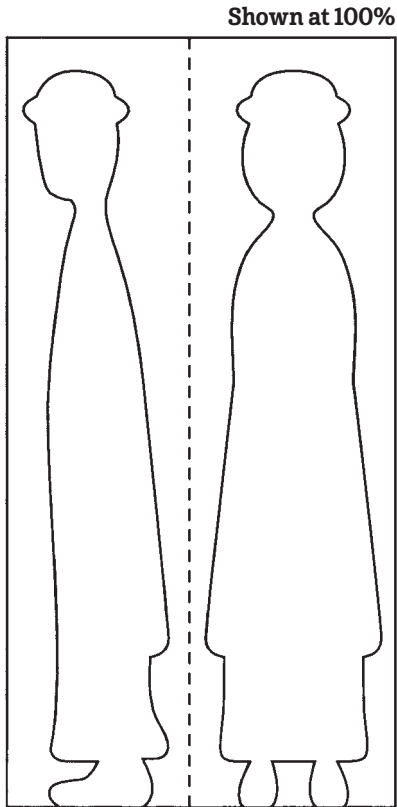

Joseph (Cut 1)

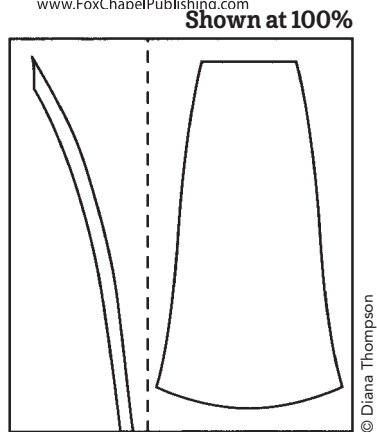

Joseph headdress (Cut 1)

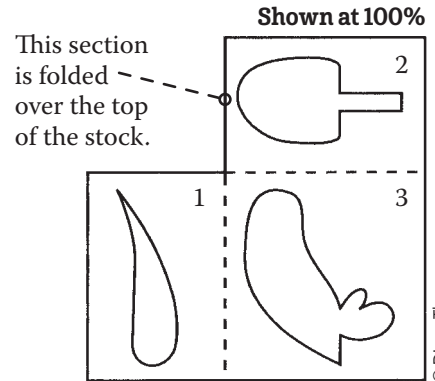

Joseph right arm (Cut 1)
Make arm cuts according to numbered sequence.

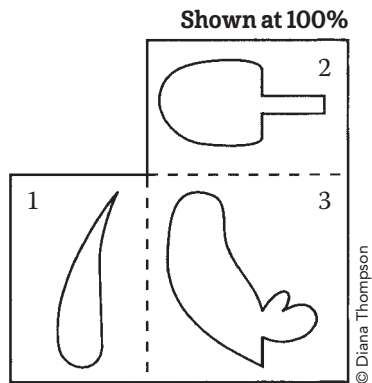

Joseph left arm (Cut 1)

Shown at 100%



Staff (Cut 1)
1/8" stock

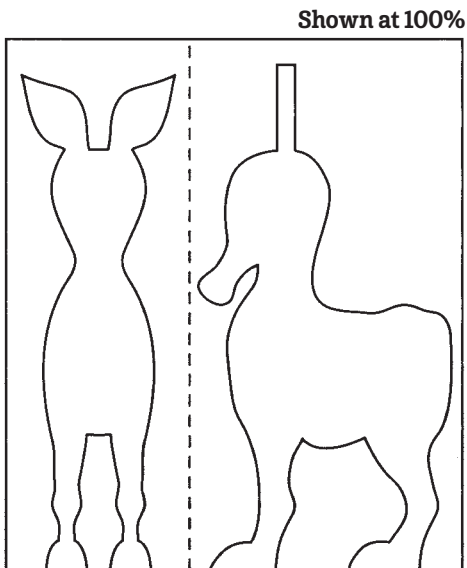

Cow (Cut 1)

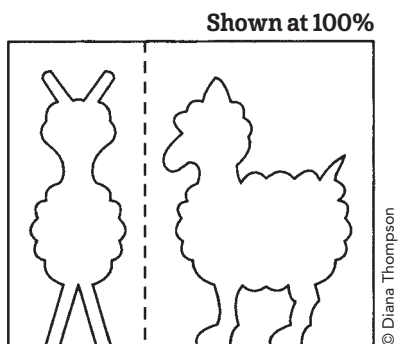

Lamb (Cut 1)

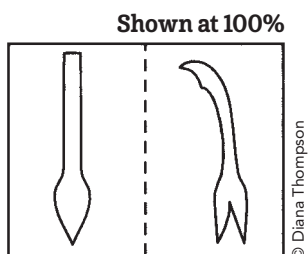

Cow tail (Cut 1)

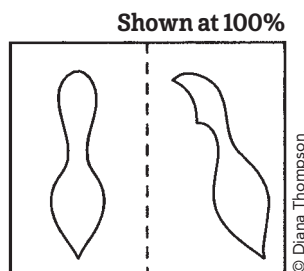

Burro tail (Cut 1)

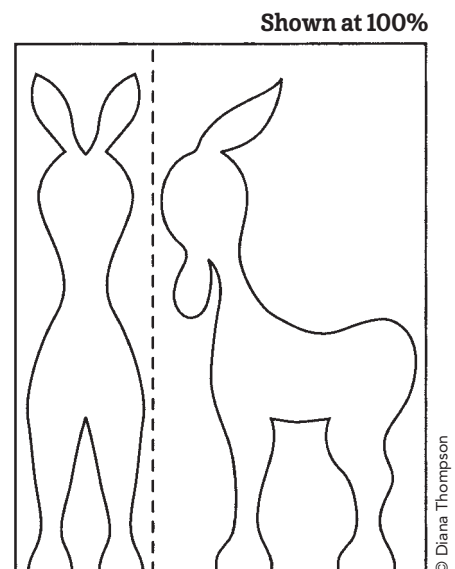

Burro (Cut 1)

Nativity Scene

Shown at 100%

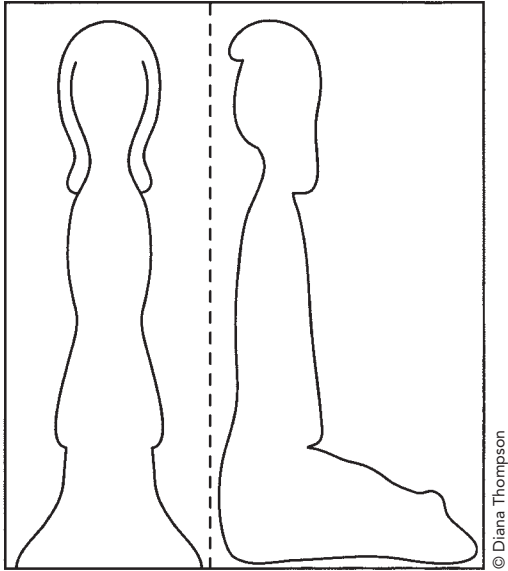

Mary (Cut 1)

© Diana Thompson

Shown at 100%

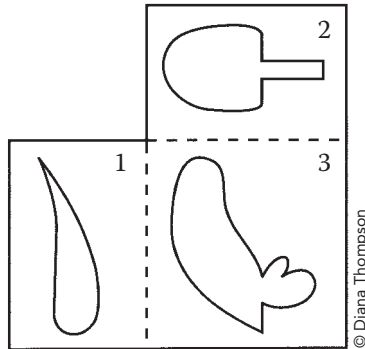

Mary right arm (Cut 1)
 Make arm cuts according to numbered sequence.

© Diana Thompson

Shown at 100%

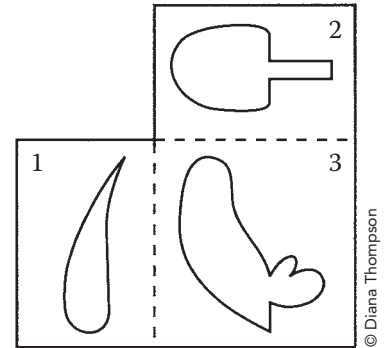

Mary left arm (Cut 1)

© Diana Thompson

Shown at 100%

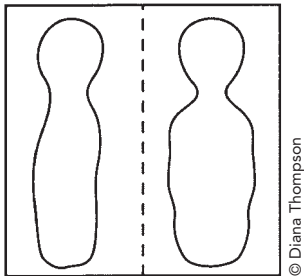

Baby Jesus (Cut 1)

© Diana Thompson

Shown at 100%

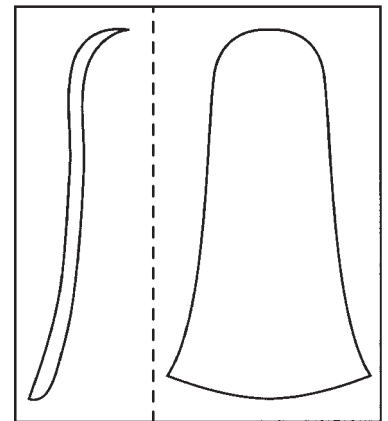

Mary's Headdress (Cut 1)

© Diana Thompson

Shown at 100%

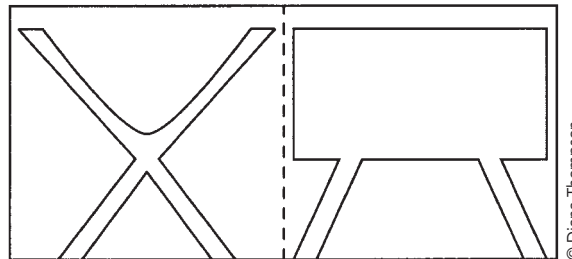

Manger (Cut 1)

© Diana Thompson

Nativity Scene

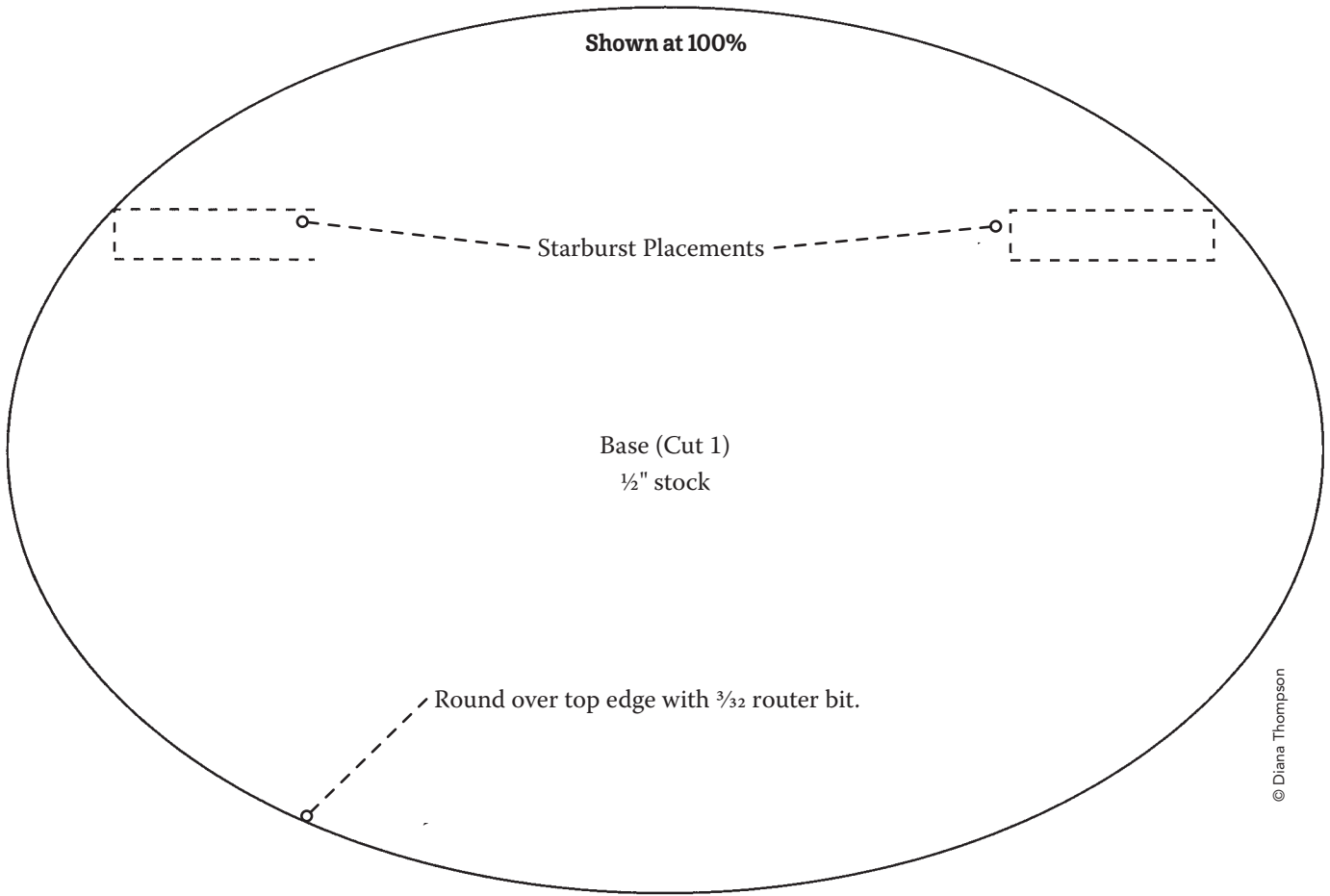

© Diana Thompson

Nativity Scene

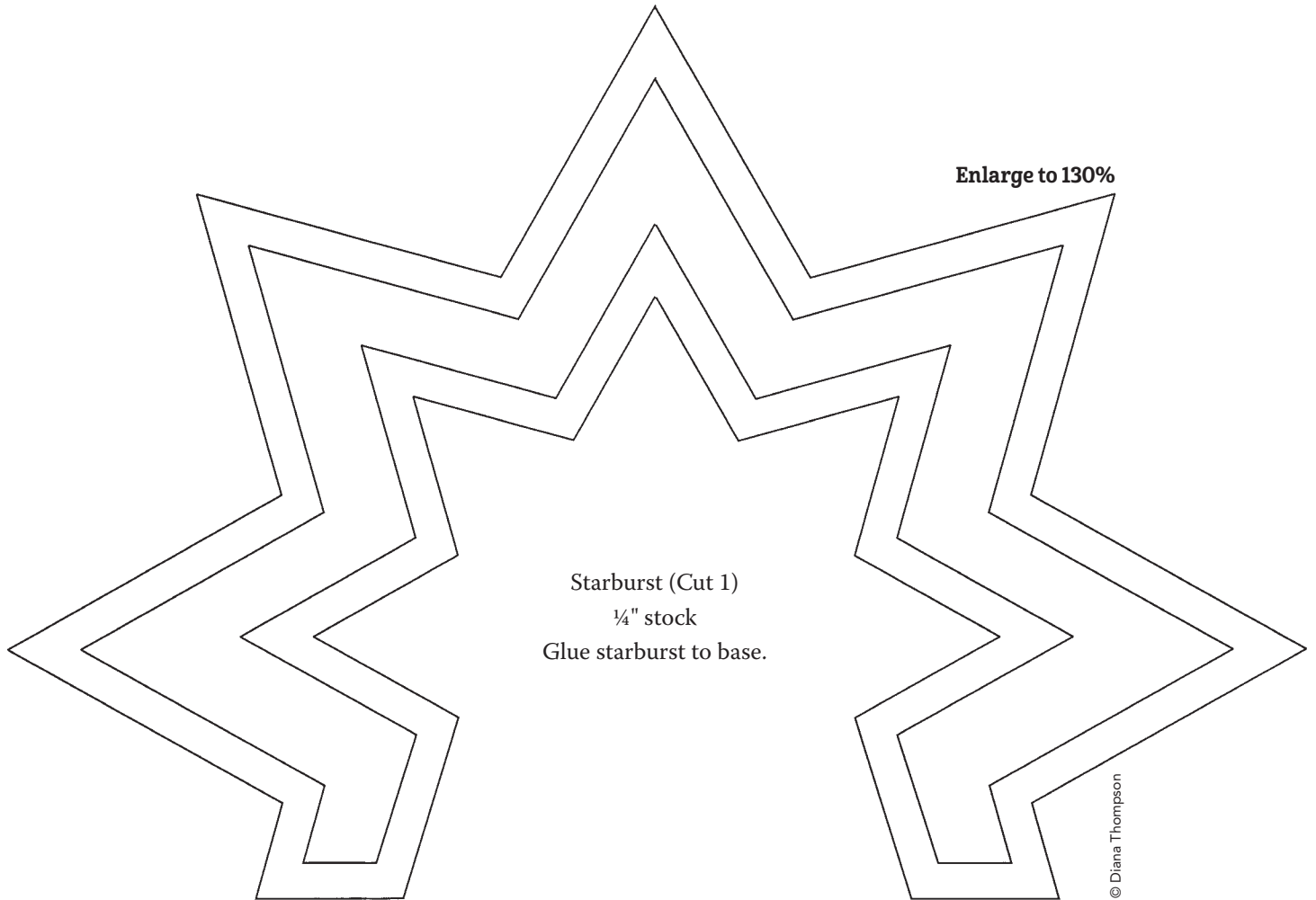

Nativity Scene

Enlarge to 130%

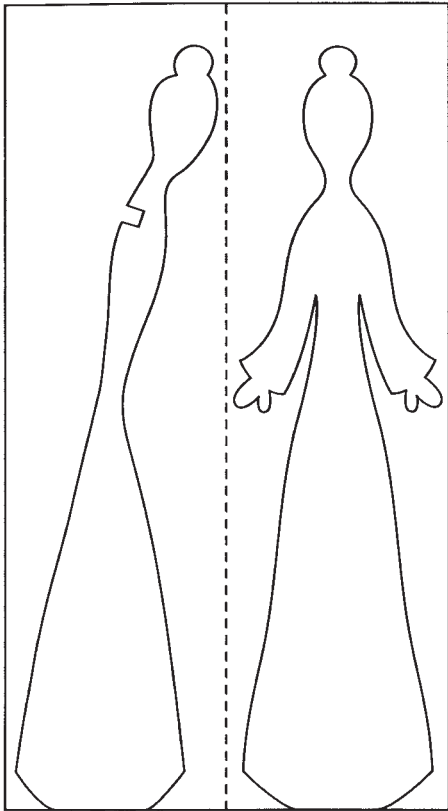

Angel (Cut 1)

© Diana Thompson

Enlarge to 130%

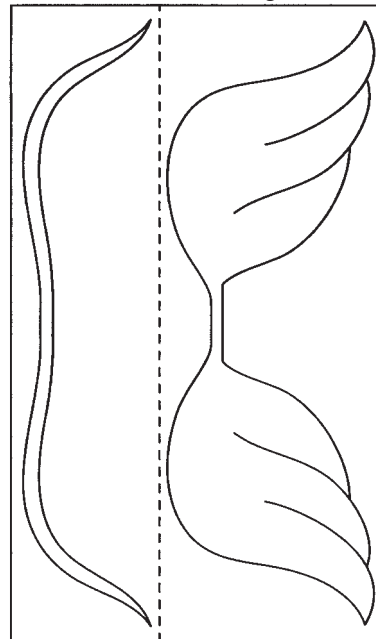

Wings (Cut 1)

© Diana Thompson

Glue wings into notch of angel body.